

Manual

Data Logger

blueberry NDL 485

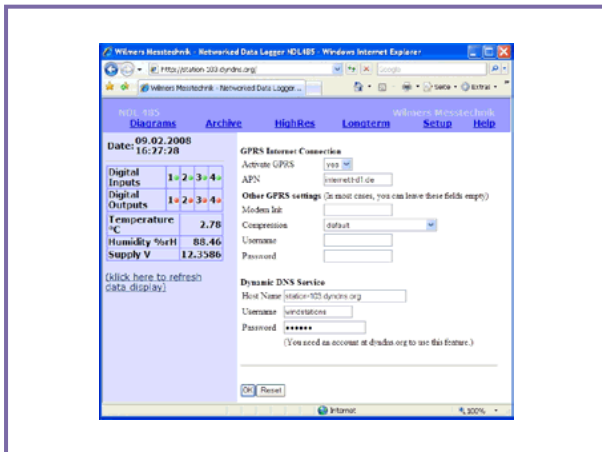
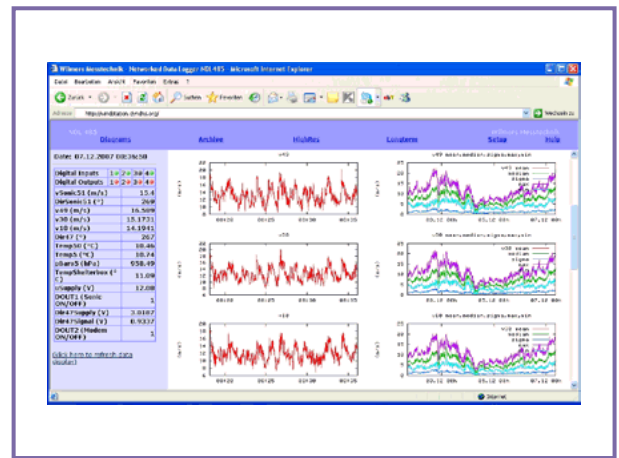
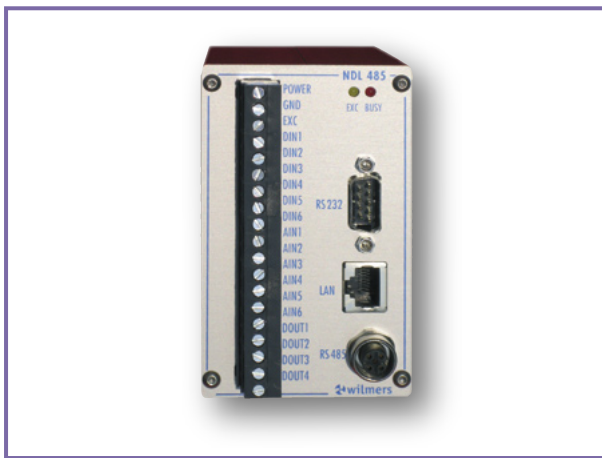

IMPRINT

Copyright:

Wilmers Messtechnik GmbH
Hammer Steindamm 35
D-22089 Hamburg / Germany
phone: +49(0)40-75 66 08 98
fax: +49(0)40-75 66 08 99
mail: info@wilmers.com
internet: www.wilmers.com

WAsP is a software product of RISØ National Laboratory, Denmark. WindPRO is a software product of EMD, Denmark. Microsoft, Windows, Excel and Internet Explorer are trademarks or registered trademarks of Microsoft Corporation, USA.

This manual relates to firmware release 3.0.0 on two models of the data logger **blueberry NDL 485**, (partNo. 0102 **basic** and partNo. 0103 **research**). Some functions are only provided by partNo. 0103.

All rights reserved. No part of this document may be reproduced or transmitted in any form or by any means, electronic or mechanical, for any purpose other than for the purchaser's personal use, without written permission. All information in this document subject to change at any time without prior notice and do not represent a commitment on the part of the manufacturer.

2010-05-30

Contents

BASIC FUNCTIONALITY (ALL MODELS)	5	EXTENDED FUNCTIONALITY (RESEARCH MODEL) 36	
Introduction	5	Displaying Diagrams	36
Getting Started	5	Shorttime Diagrams	37
Scope of Delivery	5	Statistics Diagrams	37
Installation	6	Transmitting Measured Data via FTP	38
Web Interface	8		
Introduction	8	ANNEX	39
Data Display	8	Technical Specifications	39
Displaying Actual Measured Values	8	CE Compliancy Declaration	41
Data Transfer	10	Index	43
Downloading Measured Data	10		
Data Format	10		
Transmitting Measured Data via E-Mail	12		
Site Description (Documentation)	12		
Measurement Setup	14		
Setting Measurement Parameters	14		
Setting Measurement Functions	14		
Function Names	14		
Arithmetic Operators	15		
Boolean Operators	15		
Rounding Operators	17		
Other Operators	17		
Operator Summary	18		
Variables	18		
Predefined Variables (Time Info)	18		
Setting up Data Polling	19		
Setting the Digital Outputs	21		
Testing Poll Commands	22		
Setting Date and Time	24		
Network Interface	24		
Setting the Network Parameters	24		
Internet Integration	25		
Setting up the GPRS Connection	25		
Remote Access via Internet	26		
Creating a DynDNS Access	26		
Accessing the NDL485 via Internet	28		
Accessing the NDL 485 from a Mobile Phone	28		
Remote Access via GSM	29		
Setting up the GSM Connection	29		
Accessing the NDL 485 via GSM	30		
Password Protection	31		
Setting the User Password	31		
Help Function	32		
Rebooting the NDL 485	32		
FTP Access	33		
Installing FileZilla	33		
Deleting Measured Data	33		
Updating the Firmware	34		
Adapting the PC Network Settings	35		

BASIC FUNCTIONALITY (ALL MODELS)

The following chapters describe the basic functionality provided by all models of the data logger **blueberry NDL 485**. The **research** model offers additional function, like creation of realtime diagrams and FTP data transfer. These extended functionality is described in part **EXTENDED FUNCTIONALITY**.

Introduction

The **blueberry NDL 485** is a modular data logger and control system. It features digital and analogue measurement inputs for the connection of sensors providing pulses, voltage or current signals. A serial **RS485** bus interface allows the connection of sonic anemometers and the extension of the measurement system with **blueberry INPUT Modules**. The digital outputs control external devices and they trigger alarms. The **blueberry NDL 485** is integrated into the Internet via GSM/GPRS or DSL. It sends measured data automatically via E-Mail and FTP. The Ethernet port and the integrated web interface provide fast data transmission to a PC or a LAN and easy access via a web browser.

Getting Started

Scope of Delivery

The following components are supplied with the data logger **blueberry NDL 485**:

- Data logger in an aluminium top-hat rail housing
- RS485 data cable with 5 pin M12x1 connector
- Crosspatch Ethernet cable for local data connection
- Manual

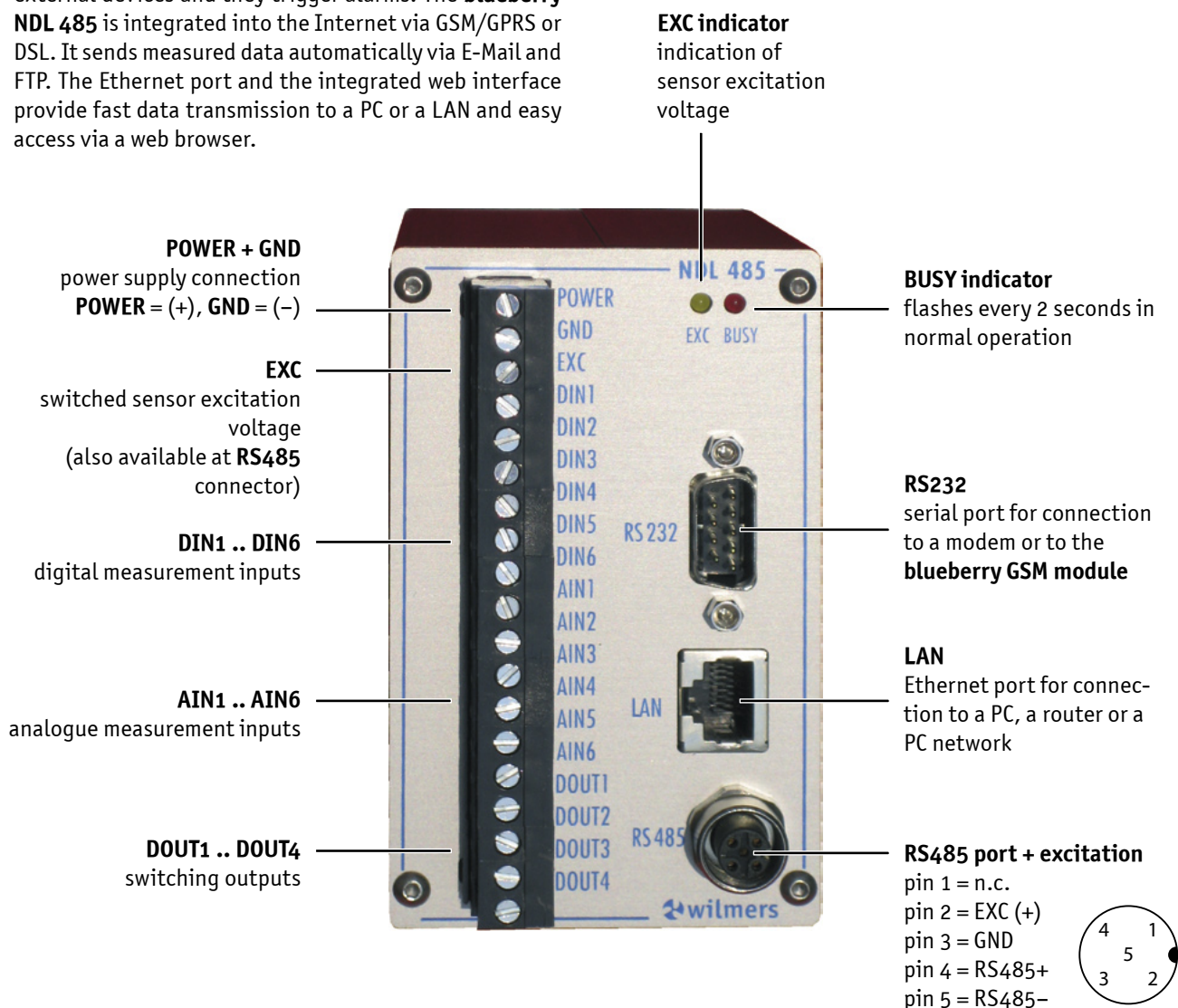

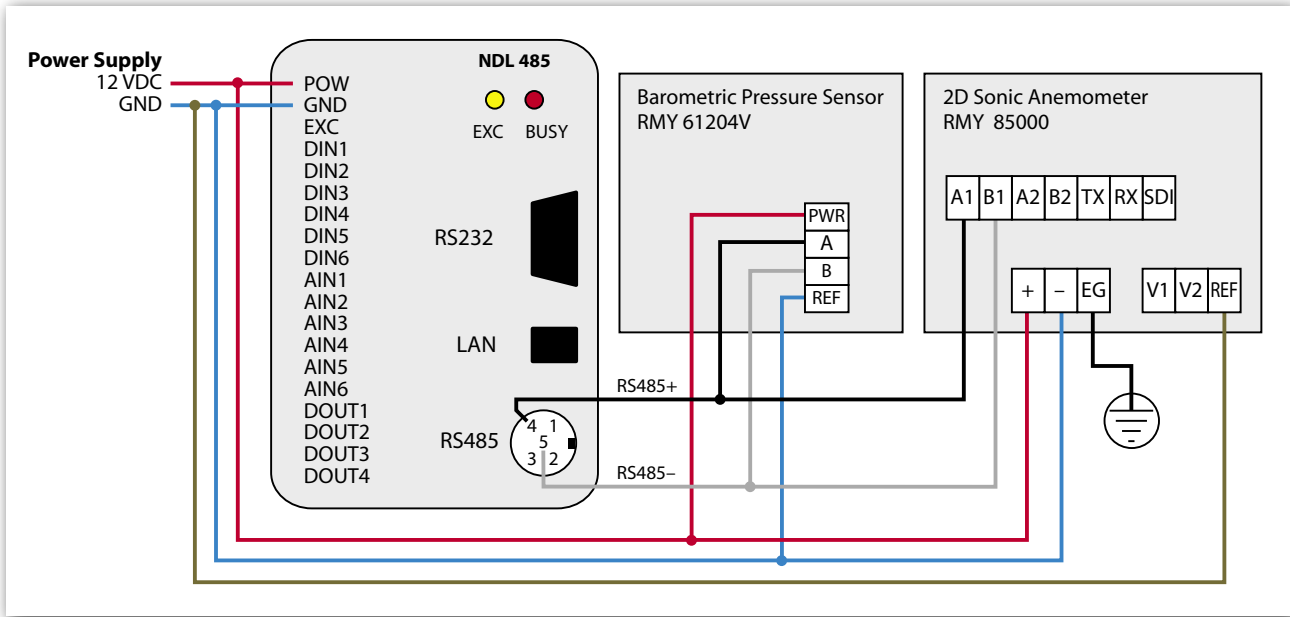

Example: wiring of RS485 bus

Installation

Please proceed as follows to install and to test the **NDL 485** data logger:

1. Install the **NDL 485** on a top-hat rail.
2. Connect a power source of 5..24 VDC to the **POWER** and **GND** terminals of the terminal strip. The **BUSY** indicator LED starts flickering or is steadily alight. The boot process takes approx. 2 minutes. The data logger is fully operating when the **BUSY** LED flashes in regular intervals of 2 seconds.
3. Plug the crosspatch cable into the **LAN** connection at the front plate of the **NDL 485**. Connect the crosspatch cable to the Ethernet interface of a PC or notebook.
4. Adapt the network settings of the PC to the IP address and the gateway of the **NDL 485**. The network parameters are indicated on a label at the bottom of the housing of the data logger.
5. Start your Internet browser, enter the IP address of the data logger into the address field and type **<enter>**. Enter the access code into the login dialog:

user: **admin**
 password: ******** (=admin password)

6. You should now see a screen similar to the image below.

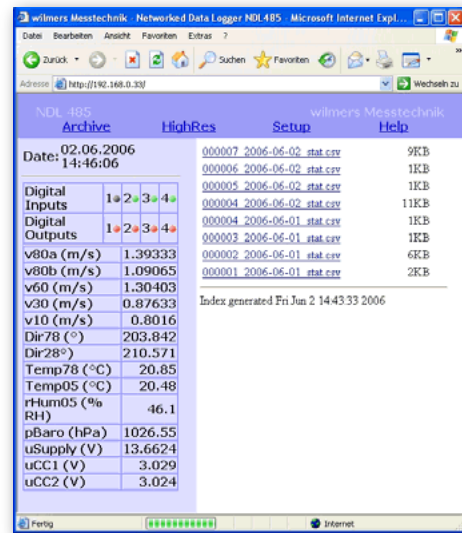

Web Interface of the **NDL 485**

7. Connect sensors or test signals to the terminals at **DIN1 .. DIN6** and **AIN1 .. AIN6**. Enter the measurement functions according to chapter **Measurement Setup** of this manual.

We recommend to install the **NDL 485** in a shelter box with overvoltage protection modules for all terminals. The following image shows a typical measurement system with the **NDL 485** data logger, one **INPUT module**

(20 measurement inputs in total) and the **GSM module** that integrates the data logger into the Internet via GPRS. A solar power supply and a set of overvoltage protection modules complete the system.

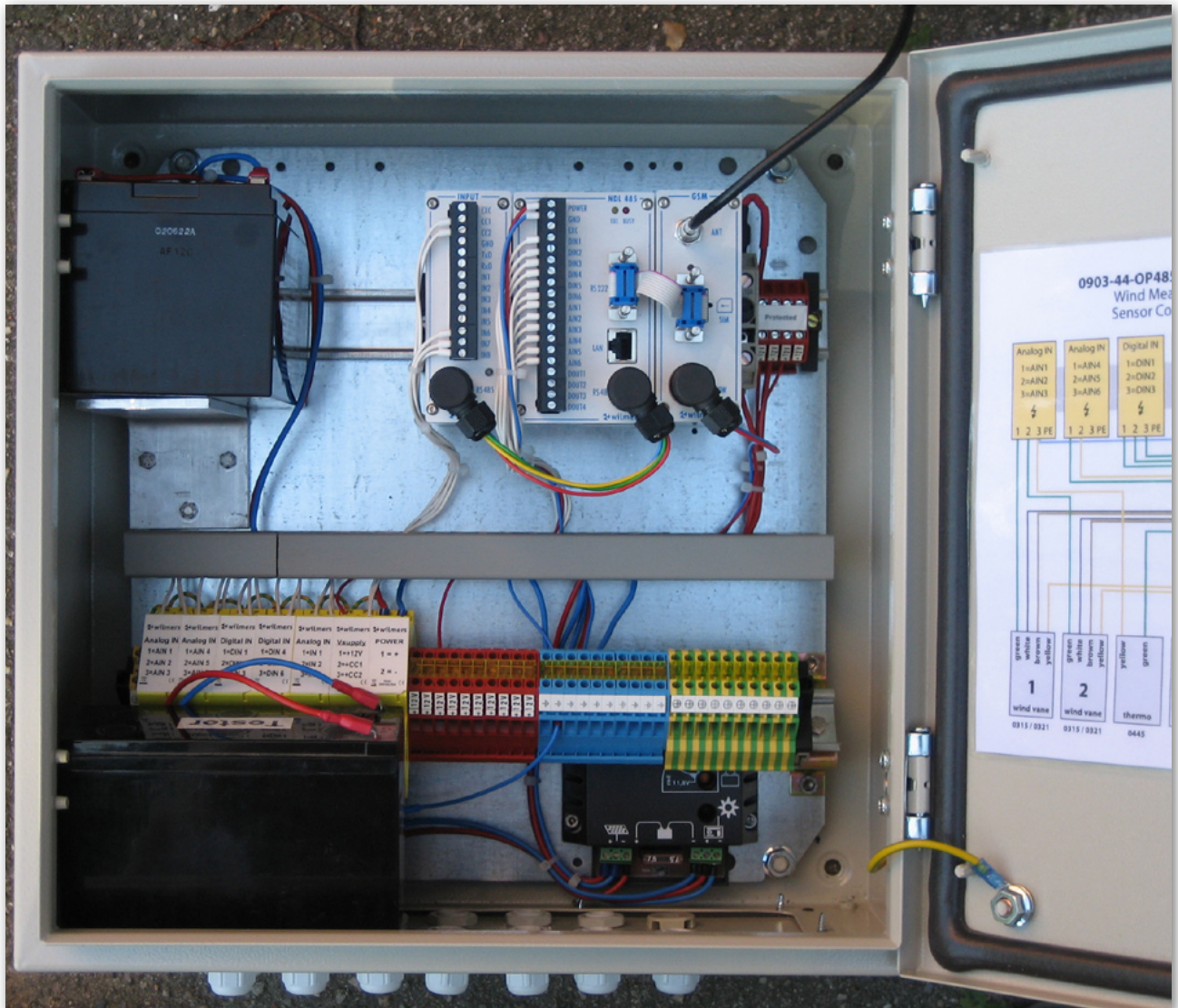

Shelter Box 0903-44-OP485 with overvoltage protection, solar power supply, data logger, **blueberry INPUT module** and **blueberry GSM module**

Web Interface

Introduction

The user surface of the data logger **blueberry NDL 485** is a web interface. Configuration of the data logger, display and download of measured data requires a web browser (e.g., Internet Explorer, Opera, Mozilla). The data logger is connected to the PC locally via Ethernet or via remote data transmission (DSL, GSM, GPRS).

Start the browser, enter the IP address of the data logger into the address field and type **<enter>**. Enter the access code into the login dialog. The **NDL 485** provides two user levels:

The user **guest** is allowed to display actual measured values and configuration settings and to download measured data. He cannot delete any data or change configuration settings. He is only allowed to set date and time.

The user **admin** has all rights. In addition to the **guest** rights he is allowed to delete measured data and to change the configuration.



Login Dialogue

Data Display

Displaying Actual Measured Values

The left part of the screen displays in a table all actual measured values. When the data logger is connected locally these values are automatically updated. At remote connections, please click on **Refresh Data View** below the data table in order to update the display. Measured values are displayed as floating point numbers with the significant number of characters after the decimal point.

Digital Inputs	1	2	3	4
Digital Outputs	1	2	3	4
Temp (°C)	20.56			
rHumidity (%RH)	43.13			
pBaro (hPa)	1026.13			
vSonic (m/s)	4.76698			
dirSonic (°)	117.227			
vSupply (V)	12.0955			
Freq1 (Hz)	0			
densityAir (kg/m ³)	1.21709			

Realtime Display of Actual Measured Values

NOTES

Data Transfer

Downloading Measured Data

The **NDL 485** contains two ring buffer data memories; one for the statistics, one for the samples. Actual data overwrite the oldest data lines which makes the deletion of the memory unnecessary.

Select **Archive** in order to display a list of all stored statistics files. The **NDL 485** creates one statistics file per day. These files contain time series of the statistical evaluations of the samples. The file name contains the index of the actual measurement, the date and the tag **stat** for ‚statistics‘. The data logger increments the index every time the configuration is changed or the data logger reboots.

Example: **000024_2004-03-19_stat.csv**

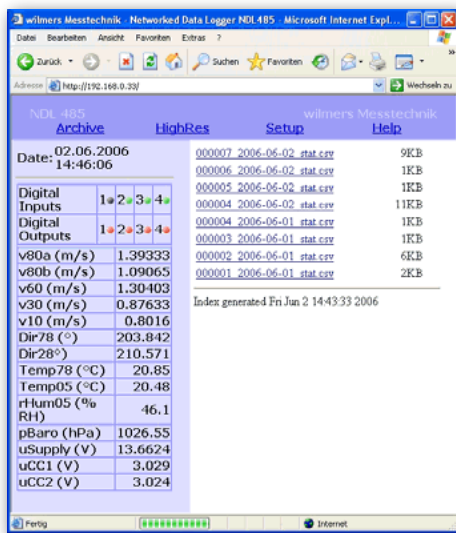

Archive: statistics data files

Select **HighRes** in order to display a list of all stored samples files. The **NDL 485** creates one CSV file per hour. These files contain time series of all measured samples. The file name contains the index of the actual measurement, date and time, and the tag **meas** for ‚measurement‘.

Example: **000024_2004-03-19_15_meas.csv**

Download of measured data works like a download from an Internet site: click with the right mouse button on a file, select **Save file as...** from the pulldown menu, enter the destination path and click **OK**.



Download of Measured Data

CSV files can be imported into data analysis software like **WASP** or **WindPRO**. Double-clicking on the CSV file opens it directly in **MS-Excel**.

Data Format

The **NDL 485** stores measured data as comma separated ASCII files (CSV). Each data file contains a header which indicates information about the data logger and the measurement configuration: serial number of the data logger, index of the measurement, measurement functions and parameter settings. The header is followed by an empty line and a line with column headers. The measured data lines have the format: date, time, period, measured values. Decimal delimiter is a dot (e.g., **2.564**).

```

C:\Daten\messdaten\ndl485-sn2016\000009_2007-11-15_stat.csv - PROTON
Datei Bearbeiten Ansicht Syntaxschema Tools Shortcuts Plugins History ?
2_000009_2007-11-15_stat.csv
1 # instrument NDL485-3218974759
2 # measurement 000009
3 # pollperiod=1
4 # statperiod=600
5 # pollexcitate=0
6 # function="vSonic51 (m/s)",(mean,sigma,max,min,median),c2
7 # function="DirSonic51 (°)",(mean,sigma,mean360),"(c3+20) % 360"
8 # function="v49 (m/s)",(mean,sigma,max,min,median),"0.04773 * b2 + 0.272 * (b2>0)"
9 # function="v30 (m/s)",(mean,sigma,max,min,median),"0.04773 * b4 + 0.268 * (b4>0)"
10 # function="v10 (m/s)",(mean,sigma,max,min,median),"0.04774 * b6 + 0.254 * (b6>0)"
11 # function="Dir47 (°)",(mean,sigma,mean360),"(((358 * (a2-a1) / a2) + 20) % 360) - (((358 * (a2-a1) / a2) + 20) % 360) % 1)"
12 # function="Temp50 (°C)",(mean,max,min),"100 * a4 - 30"
13 # function="Temp5 (°C)",(mean,max,min),"100 * a5 - 30"
14 # function="pBaro5 (hPa)",mean,d19
15 # function="TempShelterbox (°C)",mean,d20
16 # function="uSupply (V)",(mean,max,min),"a8 - (a8*0.01)"
17 # function="DOU1 (Sonic ON/OFF)",mean,"uSupply > 10.5"
18 # function="Dir47Supply (V)",(mean,max,min),a2
19 # function="Dir47Signal (V)",(mean,max,min),a1
20 # function="DOU2 (Modem ON/OFF)",mean,"!( (HOUR == 0) * (MINUTE == 45) )"
21 # pollbaudrate=9600
22 # pollchardelay=20
23 # poltleleddelay=100
24 # polltimeout=1
25 # pollretry=0
26 # poll=analog
27 # poll=digital
28 # poll=MS1,9600
29 # poll=#01\r,19200
30
31 "date","time","period","vSonic51 (m/s)_mean","vSonic51 (m/s)_median","vSonic51 (m/s)_sigma","vSonic51 (m/s)_max","vSonic51 (m/s)_min",
32 2007-11-15,00:10:00,600,2.33094,2.4,0.650467,3.6,0.8,359.696,14.8823,2.20153,2.17595,0.618092,3.81452,0.89249,1.48491,1.42736,0.590033
33 2007-11-15,00:20:00,600,2.25415,2.3,0.647789,3.6,0.5,350.242,8.94578,2.17612,2.22082,0.642639,3.99589,0.707775,1.38549,1.24599,0.66159
34 2007-11-15,00:30:00,600,2.00883,2.0,0.745324,3.5,0.2,355.042,20.7658,1.96232,1.88289,0.692048,4.2417,0.626157,1.25282,1.18919,0.593721,2
35 2007-11-15,00:40:00,600,2.23423,2.4,0.655743,3.6,0.4,18.0246,17.7095,2.02761,1.98646,0.536114,3.38161,0.709684,1.46321,1.36865,0.56556
36 2007-11-15,00:50:00,600,3.05668,3.0,0.672514,5.4,1.3,14.7454,14.4967,2.85232,2.72866,0.743432,5.08414,1.30822,2.04201,1.90418,0.687686,4

```

Statistics data file in an ASCII editor

date	time	period	vSonic51 (m/s)_mean	vSonic51 (m/s)_median	vSonic51 (m/s)_sigma	vSonic51 (m/s)_max	vSonic51 (m/s)_min	Dir
15.11.2007	00:10:00	600	2.33094	2.4	0.650467	3.6	0.8	
15.11.2007	00:20:00	600	2.25415	2.3	0.647789	3.6	0.5	
15.11.2007	00:30:00	600	2.00883	2	0.745324	3.5	0.2	
15.11.2007	00:40:00	600	2.23423	2.4	0.655743	3.6	0.4	
15.11.2007	00:50:00	600	3.05668	3	0.672514	5.4	1.3	

Statistics data file in MS Excel

Transmitting Measured Data via E-Mail

The **NDL 485** sends measured data automatically via e-mail every day at 0:00. The CSV data file of the previous day is attached to the e-mail. If several files have been created since last e-mailing (e.g., because of configuration changes or rebooting of the data logger) all closed files are sent. Each file is attached to a separate e-mail. Please first setup the Internet integration via GPRS or DSL.

To setup the e-mail data transfer select **Setup > FTP/Mail**.

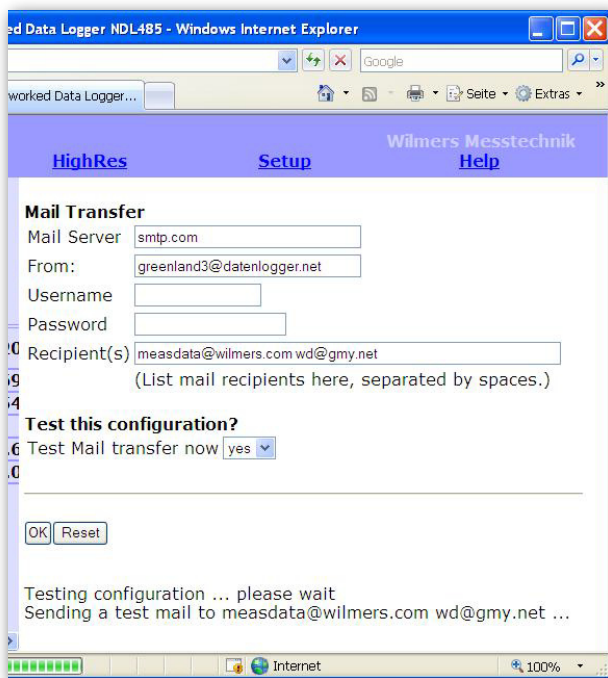

Setup: E-Mail Data Transmission

Enter the URL of your mail server (SMTP server) in the field **Mail Server**. If your mail server requires authorization enter the user name and password. Enter the mail addresses in the field **Recipient(s)**. Separate more than one mail address by space characters.

Select **yes** at **Test Mail Transfer now**.

Click **OK** to save the settings. If the **Test Mail** option is active the **NDL485** now sends a test mail to all recipients. A message displays the result of the test mailing. Please check whether the mail has been sent without errors. Otherwise, please check the correctness of your settings.

Site Description (Documentation)

The **NDL 485** saves information about the measurement. They are stored in the header of each CSV data file for proper documentation of the measurement process.

To enter the information about the measurement select **Setup > Site Description**.

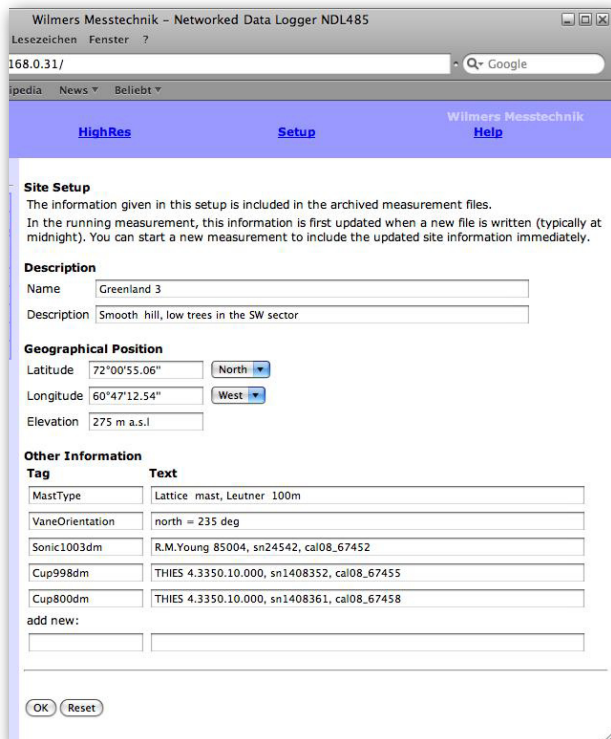

Setup > Site Description (Documentation of the Measurement)

Documentation of the measurement includes the following information:

Name	Name of the measurement site
Description	Description of the measurement location and its environment. Please enter here orography, roughness, obstacles and other elements having an impact on the measurement result.
Geographical Position	Enter here latitude, longitude and elevation of the measurement site.

Other Information Use these universal input fields to enter all supplementary information about the measurement:
e.g., geographical coordinate system, mast type, mast dimensions, type, serial numbers and calibration numbers of the sensors, dimensions and alignment of sensor mounting booms

Measurement Setup

Setting Measurement Parameters

To define measurement parameters or sensor characteristics select **Setup > Measurement**:

Measure Period Measure period is the time interval in which the data logger records actual measured values (samples) from all sensors.

Statistic Interval Statistic interval is the time interval in which the data logger performs a statistical evaluation of the samples and stores the results in the memory. The variables **a1..an** correspond to the first to nth value of the data line sent by the first sensor. The variables **b1..bn** correspond to the values sent by the second sensor and so further.

Excitation defines how long the sensor excitation voltage (**EXC**) is switched on before the **NDL 485** sends a poll command.

Selecting **always on** switches the excitation voltage continuously on. The **blueberry INPUT Module** requires this setting as it needs a warm-up time of approx. 5 seconds.

Setting Measurement Functions

To add a new measurement function enter a function name in the field **Name**, check the required statistical evaluations and enter the measurement function. Type **<enter>** to transmit the settings to the data logger.

Function Names

Variable names may principally contain umlauts (**ä, ö, ü**) and special characters like comma (,) and period (.). If function names are used as variables in further measurement functions the first part of the function name may however only contain the following characters: **A..Z, a..z, 0..9, _**. The second part, i.e. the part after the first space character is used as axis label for realtime diagrams. We recommend to use the following syntax for function names: **Value (unit)**.

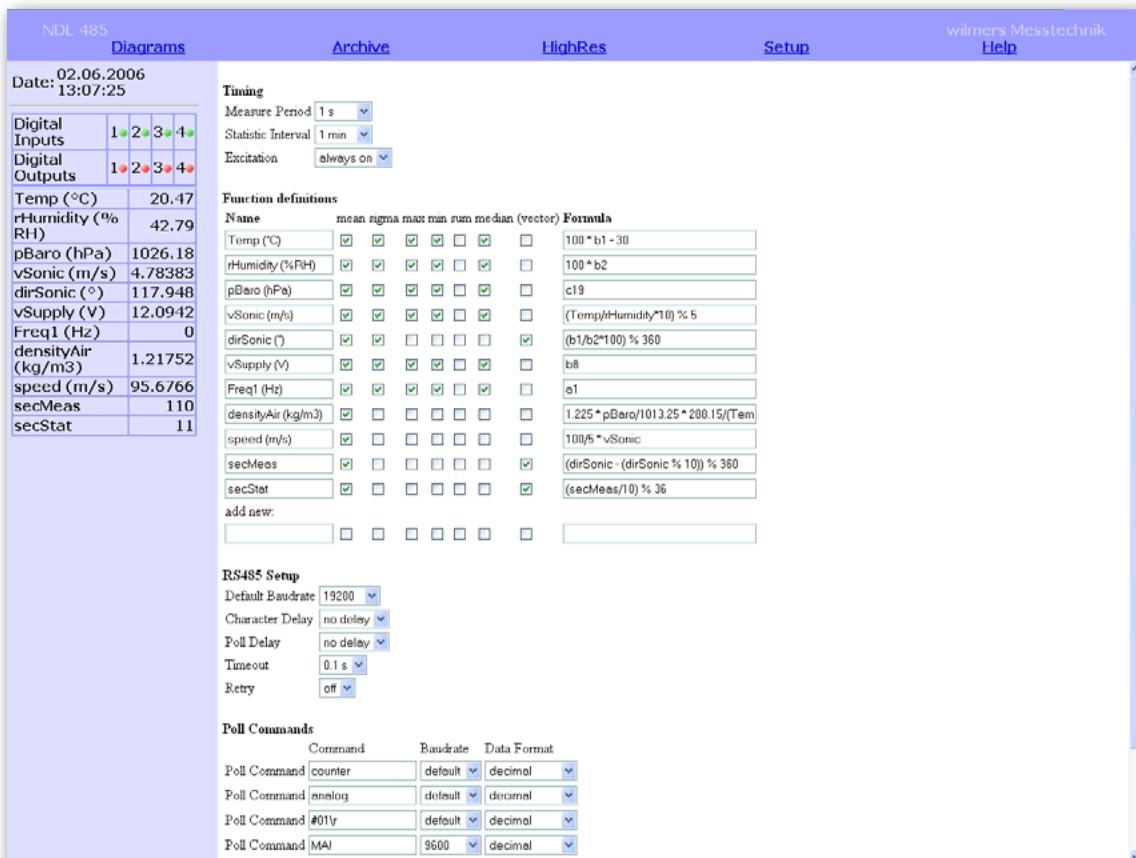

Setup > Measurement: Measurement Parameters and Measurement Functions

Example:

$$vWind80m (m/s) = 0.04727 * b10 + 0.264 * (b10 > 0)$$

The first part of the function name can be used as variable **vWind80m** in further measurement functions. The diagram title for this function is **vWind80m**, the y axis label is **(m/s)**.

Maximum length of the measurement function including function name and statistics options is 1023 characters or 64 elements. Each variable or operator counts as one element. Please use the following elements to built the measurement function:

Arithmetic Operators

+ Addition

- Subtraction or minus sign. If a - is used to characterize a negative number at the beginning of a measurement function or after another operator the number must be put into parenthesis.

Example: **Negative Numbers**

$$HumAir (\%RF) = (-25) + 62.5 * a5$$

$$vSonic (m/s) = e2 \text{ else } (-9999)$$

* Multiplication

/ Division

^ Exponent, real number

Example: **Length of a Vector**

$$uSonic (m/s) = d2$$

$$vSonic (m/s) = d3$$

$$wsHorizontal (m/s) = (uSonic^2 + vSonic^2)^{0.5}$$

This function converts the **u** and **v** components of a sonic anemometer to horizontal wind speed.

% Modulo division. This operator provides the positive residue of a division. Unlike the general modulo operator defined for integer numbers, the **NDL 485** modulo operator is based on real (floating point) numbers for parameters and for the result. The second parameter of the % function must be positive (**a % b** with **b > 0**).

Example: **Wind Direction**

$$winddirection (^\circ) = (360 * b1 / b0 + 268) \% 360$$

The measured wind direction value with an offset correction of **268** degrees is projected into the range of 0..360°.

sin Sine function. The angle must be defined in degrees.

Example: **Vector Component**

$$vWind (m/s) = 0.04752 * b8 + 0.224 * (b8 > 0)$$

$$dirWind (^\circ) = (360 * (a1 - a2) / a1) \% 360$$

$$vEast (m/s) = vWind * \sin (dirWind)$$

The multiplication of the wind speed with the sine of the wind direction results in the eastern component of the total wind speed vector.

cos Cosine function. The angle must be defined in degrees.

Example: **Vector Component**

$$vWind (m/s) = 0.04752 * b8 + 0.224 * (b8 > 0)$$

$$dirWind (^\circ) = (360 * (a1 - a2) / a1) \% 360$$

$$vNorth (m/s) = vWind * \cos (dirWind)$$

The multiplication of the wind speed with the sine of the wind direction results in the northern component of the total wind speed vector.

ln Natural logarithm

Example: $\log = \ln c7$

Boolean Operators

> Comparison **superior to**. The result is **1**, if the condition is true, otherwise it is **0**.

Example: **Calibrated Cup Anemometer**

$$ws30m (m/s) = 0.04827 * c2 + 0.19 * (c2 > 0)$$

This function suppresses the wind speed offset when the frequency is **0**. Otherwise, even at total calm the data logger would indicate a wind speed of **0.19** m/s.

< Comparison **inferior to**. The result is **1**, if the condition is true, otherwise it is **0**.

Example: **Status from Threshold Value**

$$Temperature (Celsius) = 20 * a4 - 40$$

$$Frost = Temperature < 0$$

The comparison with a threshold value creates the status signal **1 = frost / 0 = no frost**.

== Comparison **equal**. The result is **1**, if the condition is true, otherwise it is **0**.

Example:

$identic = (0.2 * a2) == 1.2$

This function compares a measured value with a constant.

!= Comparison **not equal**. The result is **1**, if the condition is true, otherwise it is **0**.

Example:

$differentStatus (1=different) = c1 != c2$
with third poll command: **DIN**

This function compares the status of digital inputs **DIN1** and **DIN2**.

>= Comparison **superior or equal**. The result is **1**, if the condition is true, otherwise it is **0**.

Example:

$condensation = Humidity >= 100.1$

Relative humidity of more than 100 %RH is considered as condensation.

<= Comparison **inferior or equal**. The result is **1**, if the condition is true, otherwise it is **0**.

Example:

$DOUT1 (Heating) = Temperature <= 10.5$

A heating is switched on through switching output **DOUT1** at temperatures of or below 10.5 °C.

! **NOT** operator. This operator inverts the logical level of a boolean value.

Example:

$DOUT2 = ! a1$

with first poll command: **DIN**

Switching output **DOUT2** is set active if the status signal at digital input **DIN1** is low.

valid This operator checks whether a value is a valid number. The result is **0**, if the value is **nan**, otherwise it is **1**.

Examples: **Validity Check**

$checkValue (1=Ok) = valid (2.45 * a1)$

$error (1=invalid) = ! valid (2.45 * a1)$

if This operator checks whether a value is not **0** or **nan**. The **if** operator is typically combined with the **else** operator.

Example: **Output Limitation**

$Hum (\%RH) = 100*a4 \text{ if } (100*a4 <= 100) \text{ else } 100$

In case of condensation, some thermo hygro sensors show measured values above 100 %RH. This function limits the output of relative humidity to 100 %RH.

Example: **Validity Check**

$vCup (m/s) = 0.253 * b8 + 0.22 * (b8 > 0)$

$vValid (m/s) = vCup \text{ if } ((vCup >= 0) * (vCup < 90))$

This function defines a range of **0** to **90 m/s** for valid wind speed values. The result of $vValid$ is $vCup$ if $vCup$ is within this range, otherwise it is **nan**.

else replaces a value if the value is **nan**.

Example: **Filtering of invalid Samples**

$uSonic (m/s) = d2 \text{ else } \#uSonic \text{ else } 0$

If the sonic anemometer returns an invalid value, the data logger will keep the previous value. If the previous value is also invalid the result is set to **0**.

Example: **Marking of invalid Samples**

$relHum (\%RH) = 100*a2 \text{ else } (-9999)$

Invalid samples (**nan**) are stored as **-9999**.

Combining boolean Results:

The multiplication operator ***** corresponds to the logical **AND** operator. The addition operator **+** corresponds to the non exclusive **OR** operator.

Example: **AND, non exclusive and exclusive OR**

$AND = (a2 >= 0) * (a2 <= 100)$

$OR = (a2 < 0) + (a5 < 0)$

$XOR = ((a2 < 0) + (a5 < 0)) == 1$

Rounding Operators

abs provides the unsigned floating point value of a signed value.

Example:

*alwaysPositive = abs (125 * g7 -75)*

int removes the decimal part of the floating point value.

Example:

*intValue = int (-2.45 * d2 + 100)*

round rounds the floating point value to the nearest integer (up or down).

Example: **Display without Decimals**

*LowResDir (deg) = round((360 * a2/a1) % 360)*

This function displays the wind direction without decimals.

Example: **Fixed Number of Decimals**

*Radiation = 0.01 * round(100 * (2.645*a2-25))*

The floating point function result is reduced to 2 decimals.

Other Operators

() Parentheses structure the function elements and determine the calculation sequence.

provides the previous value of the measurement function.

Example: **Cumulative Rainfall**

*actualRain (mm) = 0.1 * b3*

cumulRain (mm) =

*(#cumulRain+(actualRain else 0))
else actualRain else 0*

These two functions record actual and cumulative rainfall. *cumulRain* adds the actual rainfall to the previous cumulative rainfall. When the measurement starts *#cumulRain* is invalid because no previous value exists. The result is then replaced by *actualRain*. If this value is also invalid the result is set to **0**. The *else* operator defines the starting value and prevents the cumulative value from being reset in case of an invalid value of *actualRain*.

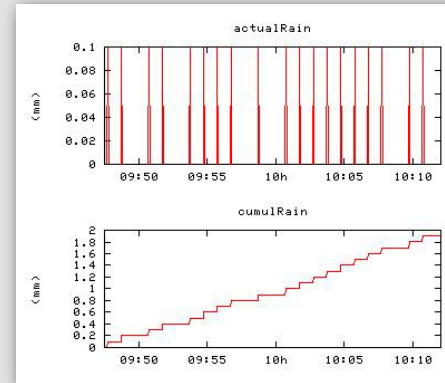

Actual and cumulative rainfall

Example: **Low Pass Filter**

*noisy = 62.5 * a6 - 55*

*damped = (0.1 * noisy + 0.9 * #damped) else noisy*

This function implements a low pass filter that smooths a noisy value. *damped* provides a damped value of the actual measurement value provided by *noisy*.

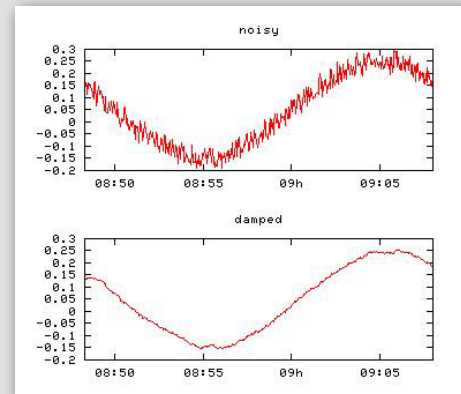

Low pass filtering of noisy data

Operator Summary

The following table lists examples of results based on the operators with different parameters.

Results for: a = ...				
	-2.7183	0	+2.7183	nan
a else b	-2.7183	0	2.7183	b
b if a	b	nan	b	nan
b if a else c	b	c	b	c
valid a	1	1	1	0
! a	0	1	0	0
a > 0	0	0	1	nan
a < 0	1	0	0	nan
a == 0	0	1	0	nan
a != 0	1	0	1	nan
a >= 0	0	1	1	nan
a <= 0	1	1	0	nan
a % 1	0.2817	0	0.7183	nan
a % 0.01	0.0017	0	0.0083	nan
a-(a%0.01)	-2.72	0	2.71	nan
abs a	2.7183	0	2.7183	nan
int a	-2	0	2	nan
round a	-3	0	3	nan
ln a	nan	nan	1.0000	nan

Variables

Variables The variables **a1..an** correspond to the first to nth value inside the data line sent by the first sensor. The **blueberry INPUT module** supplies the voltages of all inputs in Volt as well as the frequency in Hertz and the counted pulses. In addition to the variables, other function names can be used inside a measurement function. They must be defined former to the function in which they are used as a variable. A # character in front of a function name provides the measurement value of the previous measurement.

Example: Temperature Gradient
 $Temp (°C) = 100 * a3 - 30$
 $deltaTemp (°C) = (Temp - \#Temp) \text{ else } 0$
deltaTemp provides the temperature gradient.

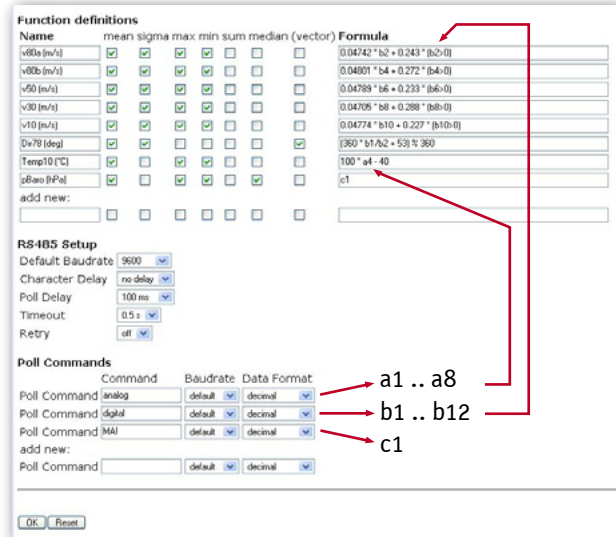

Setup > Measurement: measurement functions and variables

Predefined Variables (Time Info)

The following predefined variables provide time information.

PERIOD provides the actual measurement period in seconds.

Example: Integration over Time
 $flow (m3/s) = 125 * b2$
 $volume (m3) = flow * PERIOD$

The function *volume* uses **PERIOD** to convert actual flow into a volume.

TIME provides the time in seconds since 1.1.1970 00:00:00.

DAYTIME provides the time in seconds since 00:00:00 of the current day.

Example: Flashing Light
 $DOUT3 (flash) = ! (DAYTIME \% 10)$

This function flashes a signal lamp every **10** seconds.

YEAR provides the actual calendar year as 4 digit integer (e.g., **2007**).

MONTH provides the actual calendar month as integer (January = 1 .. December = 12).

Example: **Season dependent Factors**
 $factor = 0.26 * (MONTH < 4) + 0.22 * (MONTH == 4) + 0.25 * (MONTH > 4)$

This function selects a factor depending on the month. Some algorithms for determination of potential evaporation (e.g., HAUDE) use empirical factors that vary with the season of the year.

DAY provides the actual calendar day as integer (1 .. 31).

HOURL provides the actual hour as integer (0 .. 23).

MINUTE provides the actual minute as integer (0 .. 59).

SECOND provides the actual second as integer (0 .. 59).

WEEKDAY provides the day of the week as integer (Monday = 1 .. Sunday = 7).

YEARDAY provides the day of the year as integer (1st January = 1).

Click **OK** to save the settings into the data logger. As the measurement functions represent virtual channels they are independent of the number of hardware inputs of the data logging system. The user can define an unlimited number of measurement functions.

Setting up Data Polling

The **NDL 485** sends poll commands through the **RS 485** serial port and to the internal measurement interfaces. Each poll command provides a set of return values that are used as variables in the measurement functions. Please set the poll parameters as follows:

Baudrate Select from the **Baudrate** list the baud rate of the serial port. The **blueberry INPUT Module** requires a baud rate of **19200**.

Character Delay Select from the **Character Delay** list the delay between the characters

sent by the **NDL 485** to the serial port. Some sensors (e.g., R.M.Young sonic anemometers) require character delays. The **blueberry INPUT Module** is polled with a character delay of **0**.

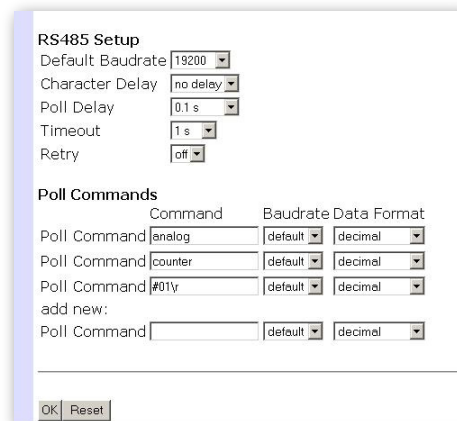

Setup > Measurement: RS485 Data Polling

Poll Pause defines the delay between the last character of a data line received by the **NDL 485** and the sending of the next poll command. The **blueberry INPUT Module** requires a poll pause of **50 ms**. The poll pause is required because the **RS 485** bus allows only one component (sensor, **INPUT Module** or data logger) at a time to transmit data. All other components work in receiver mode. The poll pause allows to switch from transmitter to receiver mode.

Timeout defines the maximum time the **NDL 485** waits for the answer to a poll command. If the polled component does not answer the poll command will be repeated once or several times depending on the value set for **Retry**. If no data was received the measured values are stored as **nan** („not a number“).

Poll Command Enter the poll command into the field **Poll Command** and click **OK** to save the setting into the data logger.

The following poll commands provide measured values from the **NDL 485** data logger itself:

Command: digital		
Results:		
Index	Value	Unit
1	Counter of DIN1	-
2	Frequency of DIN1	Hz
3	Counter of DIN2	-
4	Frequency of DIN2	Hz
5	Counter of DIN3	-
6	Frequency of DIN3	Hz
7	Counter of DIN4	-
8	Frequency of DIN4	Hz
9	Counter of DIN5	-
10	Frequency of DIN5	Hz
11	Counter of DIN6	-
12	Frequency of DIN6	Hz

Command: DIN		
Results:		
Index	Value	Unit
1	Status of DIN1 (1 = HI, 0 = LO)	-
2	Status of DIN2 (1 = HI, 0 = LO)	-
3	Status of DIN3 (1 = HI, 0 = LO)	-
4	Status of DIN4 (1 = HI, 0 = LO)	-
5	Status of DIN5 (1 = HI, 0 = LO)	-
6	Status of DIN6 (1 = HI, 0 = LO)	-

Command: **analog**

Results:

Index	Value	Unit
1	Voltage of AIN1	V
2	Voltage of AIN2	V
3	Voltage of AIN3	V
4	Voltage of AIN4	V
5	Voltage of AIN5	V
6	Voltage of AIN6	V
7	Voltage of EXC	V
8	Voltage of power supply	V

The following poll command provides measured values from the **blueberry INPUT Module**:

Command: **#AA\r** (with **AA** = 01..99 = poll address)

Results:

(serial numbers from 4001, firmware version 4.2)

Index	Value	Unit
1	Voltage of IN1	V
2	Voltage of IN2	V
3	Voltage of IN3	V
4	Voltage of IN4	V
5	Voltage of IN5	V
6	Voltage of IN6	V
7	Voltage of IN7	V
8	Voltage of IN8	V
9	Counter of IN1	-
10	Counter of IN2	-
11	Counter of IN3	-
12	Counter of IN4	-
13	Counter of IN5	-
14	Counter of IN6	-
15	Counter of IN7	-
16	Counter of IN8	-
17	Frequency of IN1	Hz
18	Frequency of IN2	Hz
19	Frequency of IN3	Hz
20	Frequency of IN4	Hz

21	Frequency of IN5	Hz
22	Frequency of IN6	Hz
23	Frequency of IN7	Hz
24	Frequency of IN8	Hz
25	Barometric pressure (only partNo.0151-P, else 0.00)	hPa
26	Onboard temperature (only partNo.0151-P, else 0.0)	°C
27	Voltage of power supply	V
28	Voltage of CC1 (constant current supply)	V
29	Voltage of CC2 (constant current supply)	V

Data Format Select the data format from the list:
decimal reads the received data values as decimal floating point numbers.
hex reads the received data values as hexadecimal values and converts them into decimal integer values (e.g., **8A** ⇒ **138**).

Click **OK** to save all settings into the data logger.

Setting the Digital Outputs

The **blueberry NDL485** provides 4 digital outputs. They are used to control peripheric devices or sensors. Digital outputs can be triggered depending on measured values or depending on time.

To set the digital outputs select **Setup > Measurement**. Define a measurement function and use **DOUT1**, **DOUT2**, **DOUT3** or **DOUT4** as function name to switch the respective output. The output is LO if the result of the measurement function is **0**, otherwise it is HI. The DOUTn tag must not be followed directly by another character. If you want to add additional text to the function name please insert a blank character after the DOUTn tag.

Example: Heating Control

DOUT1 (1=Heater ON) = **TempAir < 4**

DOUT1 activates a heater at ambient air temperatures below **4** °C.

Example: Reset Timer for GSM Modem

DOUT2 (1=Modem On) = **!((HOUR==3) * (MINUTE<1))**

DOUT2 switches a GSM modem off for one minute every day at 3:00 a.m.

Example: Timer for GSM Modem

DOUT2 (1=Modem On) = **(HOUR>=11) * (HOUR<14)**

DOUT2 switches a GSM modem on every day from 11:00 to 14:00.

Example: Timer for GSM Modem

DOUT2 (1=Modem On) = **(HOUR==8) + (HOUR==15)**

DOUT2 switches a GSM modem on every day from 8:00 to 9:00 and from 15:00 to 16:00.

Example: Flashing Light

DOUT3 (Signal) = **SECOND%2**

DOUT3 flashes a lamp every **2** seconds.

Example: Wind Speed from a specific Sector

$WS (m/s) = 0.254 * b12 + 0.213 * (b12 > 0)$
 $WD (deg) = (360 * b1/b2 + 127) \% 360$
DOUT4 (Storm) = **(WS>15) * (WD>90) * (WD<180)**

DOUT4 triggers a storm alarm for wind speeds **WS** above **15** m/s and wind directions **WD** from the sector between east and south. The multiplication operator ***** provides the logical **AND** combination of all three conditions.

Example: Switching Output with Hysteresis

$T (°C) = 100 * a4 - 40$
DOUT1 (Heating) = **(T<0) + (#DOUT1 * (T<4)) else 0**

DOUT1 controls a heating with a hysteresis. Temperatures below **0** °C switch the heating on. Temperatures above **4** °C switch the heating off.

Testing Poll Commands

Poll commands can be entered manually in order to test the response of the data logger, a sensor or an **INPUT Module**.

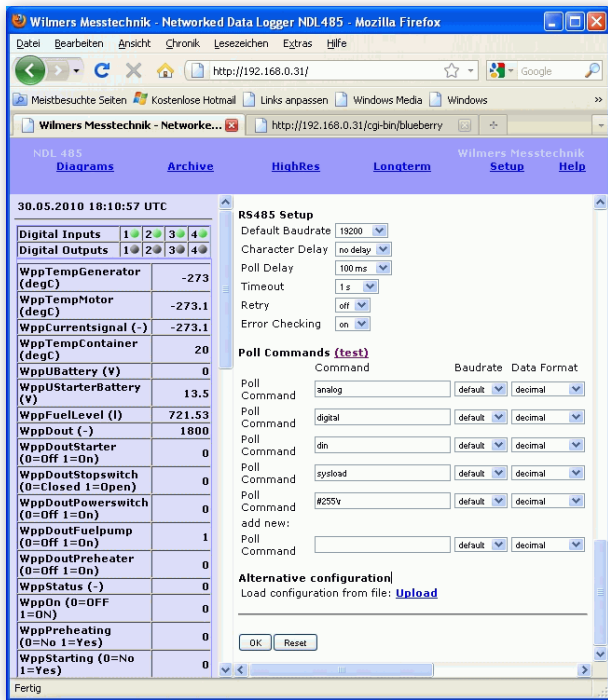

Setup > Measurement > Test poll commands

Select **Setup > Measurement**. Scroll down to **RS485 Setup** and click on **(test)** in the **Poll Commands** section. This opens a new browser window with a text terminal. Please set the RS485 interface parameters appropriate to the device to poll. Enter the poll command into the **Send** field and click on **OK**. The **NDL485** will now record all answers of the polled device during the time period defined by **Timeout** and display it in the lower part of the window.

Manual polling can be used to test whether a sensor provides proper data. It can also be used to read out the configuration of a sensor (e.g., a sonic anemometer) or of the **blueberry INPUT Module** or to change parameters in these devices. The following pictures show the testing of the analogue inputs of the data logger **NDL485** and the use with the controller of the **WindPowerPack** generator system.

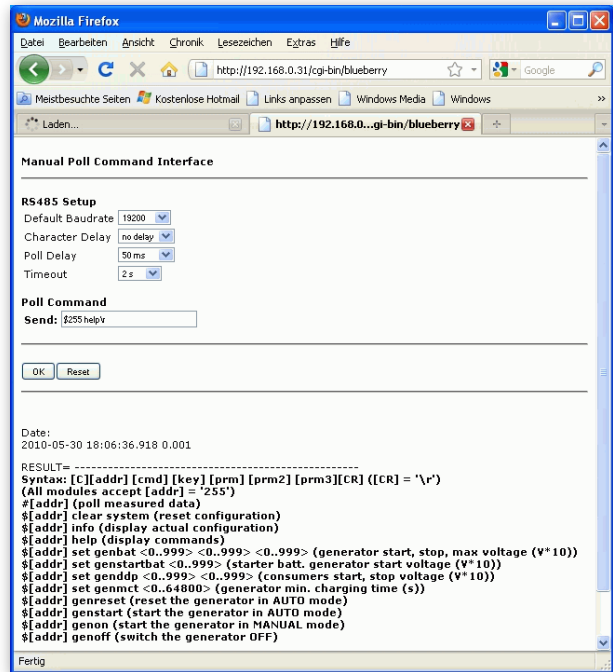

Test poll commands for WindPowerPack controller

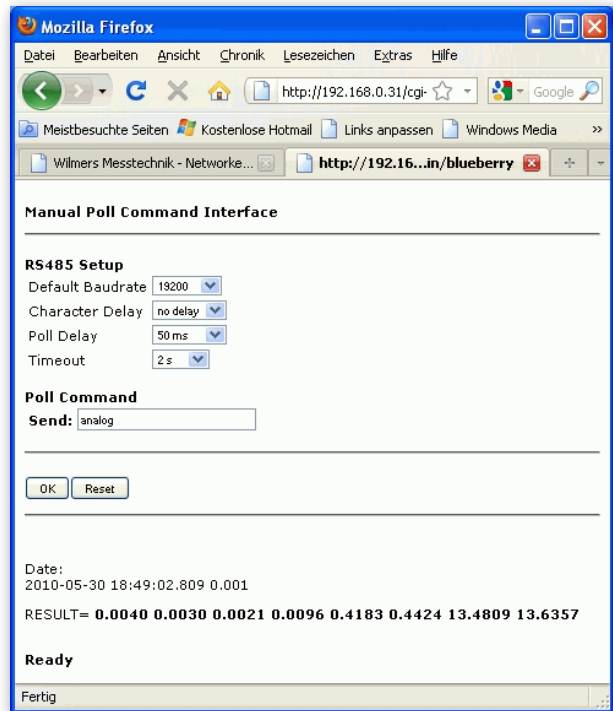

Test poll commands for analogue inputs of **NDL485**

NOTES

Setting Date and Time

If the **NDL 485** is connected to the Internet the data logger updates its internal realtime clock automatically from an Internet time server. The **NDL 485** adjusts the clock to the time zone set by the user.

Select **Setup > Date & Time** to set the parameters for realtime clock synchronization. Select the time related to UTC. Select the region where the data logger is installed. The **NDL 485** uses the time server the closest to its site in order to provide maximum accuracy. Optionally, select a time server. If you do not define a specific time server the **NDL 485** automatically selects a suitable server from a pool of time servers. Click **OK** to accept the settings.

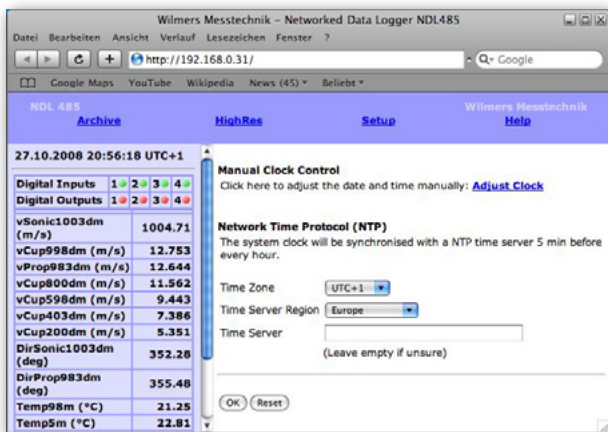

Setup > Date and Time: automatical synchronization via Internet

If the data logger is not connected to the Internet, select **Adjust Clock** to set the realtime clock manually.

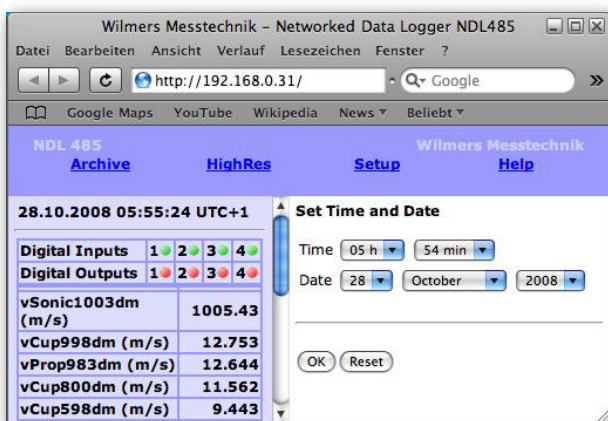

Setup > Date and Time: manual adjustment of realtime clock

Select the settings from the **Time** and **Date** lists and click **OK**.

Network Interface

Setting the Network Parameters

The **NDL 485** can be connected locally to a PC via cross-patch cable and it can be integrated into a PC network (LAN) by means of a standard Ethernet cable. The IP address of the data logger has to be adapted to the network.

Select **Setup > Network**.

Assign an IP address to the data logger.

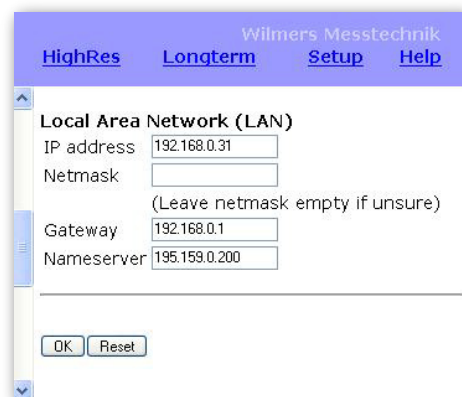

Setup > Network: LAN and local PC Connection

Enter the subnet mask required for your network type. If you are unsure about the subnet mask leave this field empty. In this case, the default subnet mask **255.255.255.0** is used.

Enter the gateway and name server (DNS) of your LAN and click **OK**. The data logger uses the gateway to built up a connection to the Internet in order to send data via e-mail or FTP and to synchronize the internal realtime clock from the Internet.

Internet Integration

The **NDL 485** is integrated into the Internet by means of a DSL router or in remote sites by means of the **blueberry GSM Module**. The **GSM Module** offers remote data transmission and realtime access via cellular phone networks (900 MHz, 1800 MHz and 1900 MHz). Two operation modes are available:

In **GSM mode**, the data logger is called from a PC by means of a telephone modem, similar to the dial-in connection to an Internet provider. This mode offers direct access to the web server of the **NDL 485**. In GSM mode, the telephone costs depend on the connection time.

The **GPRS mode** offers full integration of the **NDL 485** into the Internet. The data logger connects itself automatically to the Internet providing realtime access from any Internet access point. Two password levels protect the data logger against unauthorized access. As GPRS does not use fixed IP addresses a dynamic DNS server (e.g., dyndns.org) manages the dynamic IP address. It provides access via a named URL. The name of the server used by the **NDL 485** to access the Internet is called Access Point Name (**APN**). Private APNs provide outgoing data transmission from the data logger

to the Internet, e.g., via FTP or e-mail. However, they block access from outside into the data logger. Public APNs provide both access types. Dynamic DNS requires a public APN! Please make sure that your GSM provider offers a **public APN**. Public APNs are offered among others by T-Mobile (Germany), TIM (Italy), Telenor (Norway), WARID (Pakistan). In GPRS mode, the telephone costs depend on the volume of transmitted data.

Please prepare the following information for the GSM/GPRS setup of the **NDL 485**:

1. The data number of the SIM card. Please make sure that you are really using the data number. Usually, SIM cards have separate numbers for voice, fax and asynchronous data transmission. We recommend to use SIM cards without voice function. Pure data cards are cheaper than voice cards.
2. The PIN of the SIM card. You must disable the PIN request before use because the **NDL 485** is not able to enter the PIN. Please insert the SIM card into your mobile phone, enter the PIN and disable the PIN request.
3. The APN. Please make sure that you have got a public APN.

Setting up the GPRS Connection

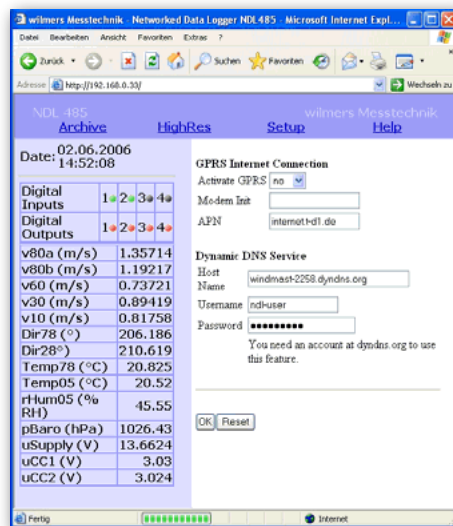

Setup > GPRS/Modem: GPRS Internet Connection

Select **Setup > GPRS** to setup a GPRS connection. Select **yes** at **Activate GPRS** and enter the APN and optionally the user name and password at **GPRS Internet Connection**. Please ask your GSM provider for these data. A list of international APNs is available in the Internet at

<http://www.quickim.com/support/gprs-settings.html>.

When the **NDL 485** operates in GPRS mode it will switch to GSM mode every day between 20:00 and 21:00. During this time the data logger is accessible via dial-in connection.

Please enter the host name of the data logger in section **Dynamic DNS Service**. Please enter the access code to your **dyndns.org** account in the fields **Username** and **Password**. The host name must be registered at <http://www.dyndns.org> before. Please refer to the following chapter for further details.

Click **OK** to save the settings.

Remote Access via Internet

GPRS networks use dynamic IP addresses. Every time the **NDL 485** connects to the Internet it gets a new IP address from the Internet service provider. If we want to access the data logger via Internet we need to know this IP address. **Dynamic DNS** manages dynamic IP addresses and provides access to them. The user defines a host name for his measurement station (e.g., station-103.dyndns.org). When the **NDL 485** connects to the Internet it sends its actual IP address to the **DynDNS** server. The **DynDNS** server translates the IP address to the host name of the data logger. This provides us access to the measurement station without knowing its IP address.

Creating a DynDNS Access

Please proceed as follows to create your account and a host at **DynDNS**:

1. Open your Internet browser and visit the web site <http://www.dyndns.org>.
2. Select **Create Account**.

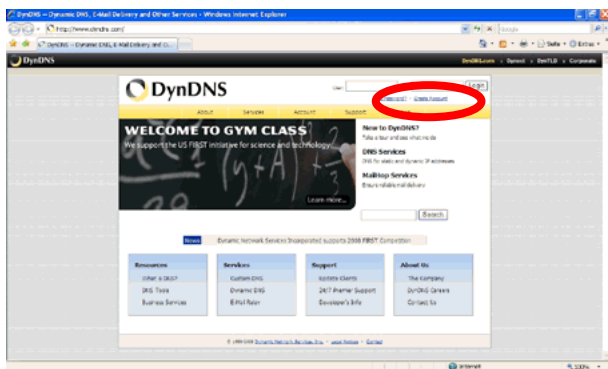

3. Define a user name, a password and enter your e-mail address.

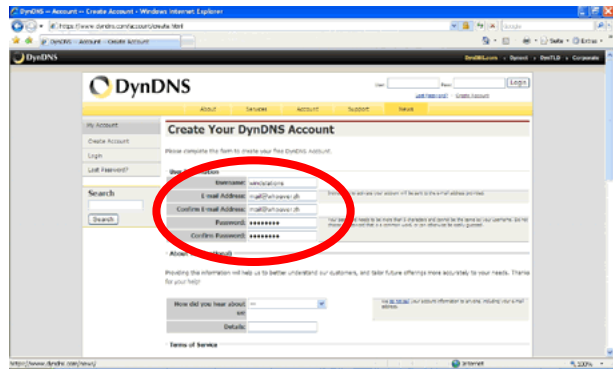

Scroll down and activate **I agree to AUP** and **I will only create one (1) free account**. Click on **Create Account**.

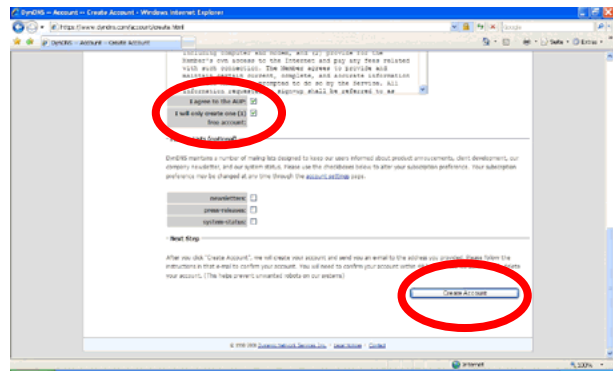

4. A message confirms the creation of your account.



5. You will now receive an e-mail with a confirmation for the **DynDNS** account. This takes typically a few minutes. Open the e-mail and follow the stated link.

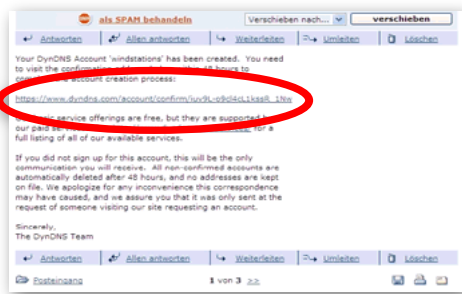

You have now created your account. The next steps create a **DynDNS** host.

6. Select **Login**.



7. Enter your access code (user name and password) and click **Login**.

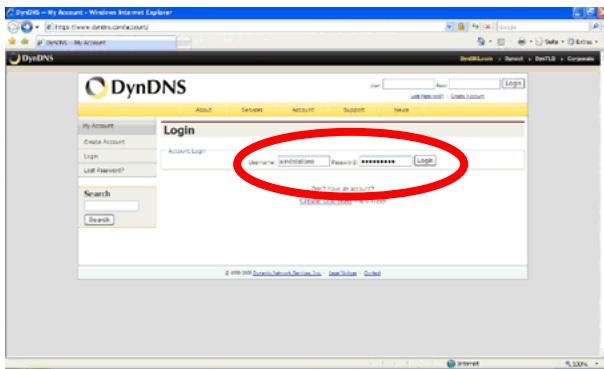

8. Select **My Services**.



9. Select **Add New Hostname**.

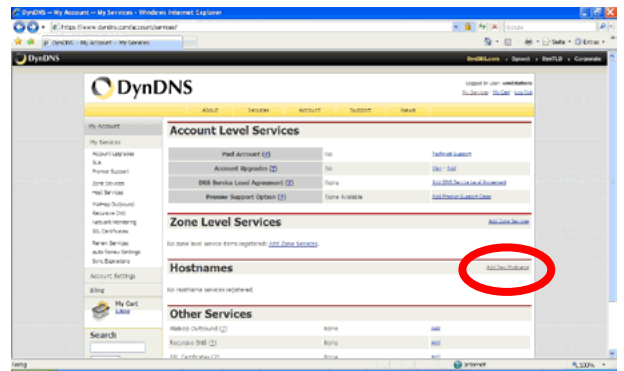

10. Enter a host name and click **Use auto-detected IP address**. Click **Create Host**.

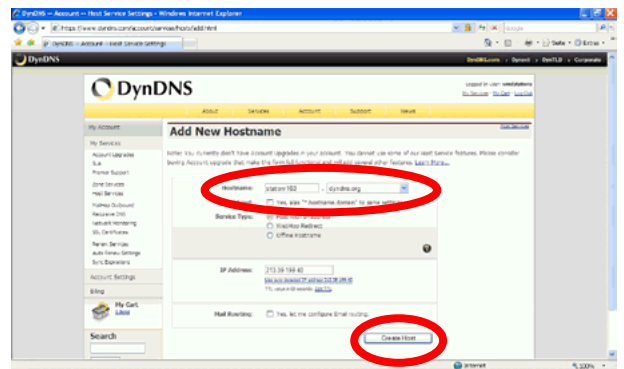

11. A message confirms the creation of the new host.

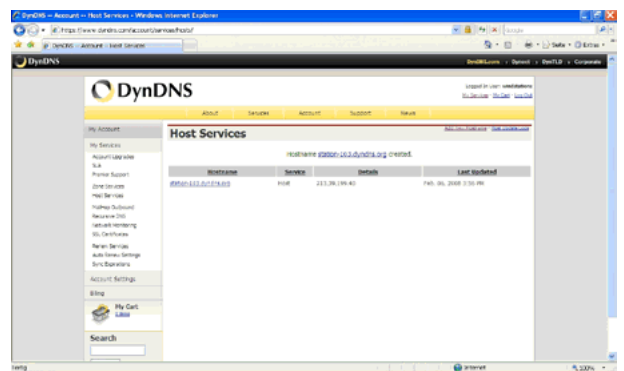

This host can now be used with the **NDL 485** (see Setting up the GPRS connection). If you want to create further hosts, please click **Add New Hostname** and repeat step 10.

Accessing the NDL485 via Internet

Please proceed as follows to access your **NDL 485** from the Internet:

Start your Internet browser, enter the **DynDNS** host name of your measurement station (e.g., station-103.dyndns.org) into the address field and hit



Internet access to an **NDL 485** research via **DynDNS** from a desktop PC

<enter>. Do not add **www** to the host name!

The remote Internet access provides the same functionality as the local access via Ethernet. The user can display and download data and diagrams and he can change the configuration.

Accessing the NDL 485 from a Mobile Phone



Internet access via **DynDNS** from a mobile phone

The **NDL 485** provides a special web interface adapted to small displays of pocket PCs, MDAs and mobile phones.

Please proceed as follows to access your **NDL 485** from an Internet capable mobile device :

1. Connect your mobile device to the Internet and start the Internet browser.
2. Enter the **DynDNS** host name of your measurement station into the address field and add **/compact** to the host name. (e.g., station-103.dyndns.org/compact). Do not add **www** to the host name!
3. Click **Connect**.
4. Enter user name and password of the data logger into the login dialog.

The functionality of the mobile access depends on the browser of your mobile device. Some mobile browsers might not be able of downloading measured data files.

Opera offers a powerful free browser for mobile phones. Please refer to <http://www.operamini.com> for further details.

Remote Access via GSM

GPRS provides the most flexible and powerful remote access to the **NDL 485**. It requires a public APN. For GSM providers that do not offer a public APN, the **blueberry GSM Module** provides remote connection to the **NDL 485** via PPP. This operation mode is similar to a dial-in connection to an Internet server. It requires a PC with analogue telephone modem.

Setting up the GSM Connection

Please proceed as follows in order to configure your Windows PC for a GSM remote connection:



1. Select **Start > Settings > Network and Dial-In Connections > New Connection**. A wizard will lead

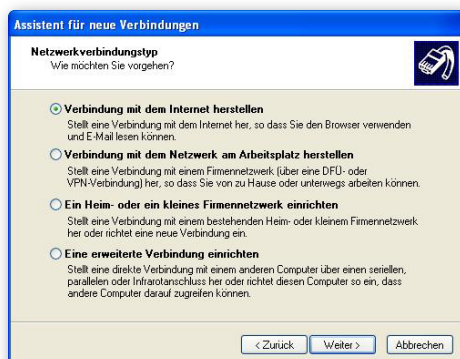

you through the configuration process.

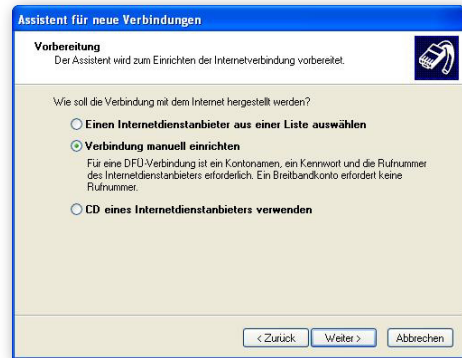

2. Click **Next**.

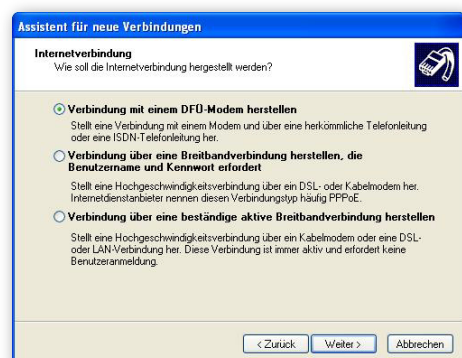

3. Select **Establish an Internet Connection** and click **Next**.

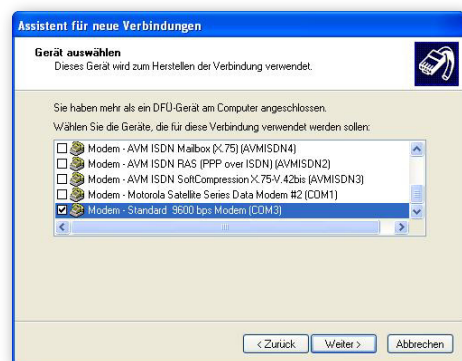

4. Select **Manual Connection** and click on **Next**.
5. Select **Modem Connection** and click **Next**.

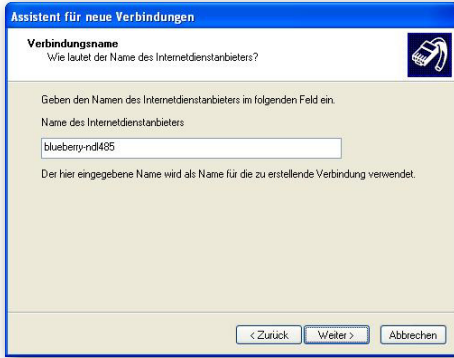

6. A list displays all modems available on your PC. Select the modem to be used for remote data transmission and click **Next**.
7. Enter a name for the remote connection, e.g., the

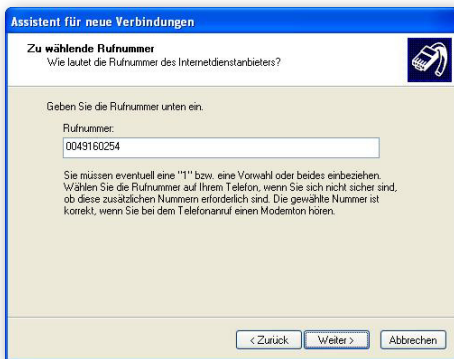

- name of the measurement site and click **Next**.
8. Enter the telephone number of the GSM modem.

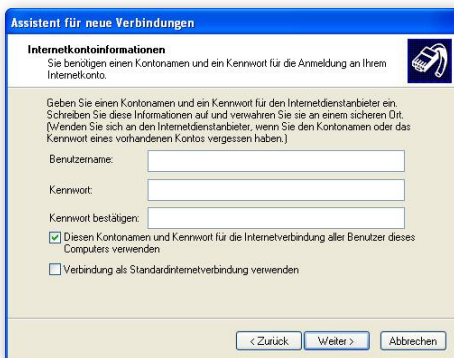

GSM SIM cards have separate numbers for fax and

data transmission. Please make sure to use the data number. Click **Next**.

9. Click **Next** without entering the access code in the dialogue.
10. Click **Next** to finish the configuration.

This chapter describes the configuration process under **MS Windows XP**. Similar wizards assist you at the configuration under **Windows 2000, Mac OS or Linux**.



Dial-in Connection under Windows XP

Accessing the NDL 485 via GSM

Please proceed as follows in order to establish a remote connection to the **NDL 485** via GSM:

1. Select **Start > Settings > Network and Dial-In Connections > blueberry-ndl485** where *blueberry-ndl485* is the name of your remote connection.

- Click on **Dial** without entering the access code. A dialogue displays the progress while connecting. When the connection has been established the dialogue box changes into an icon in the lower right corner of the task bar.
- Once the connection is established, please start your Internet browser, enter the IP address **10.1.1.1** into the address field of the browser and hit the **<enter>** key. Please note that this IP address is the same for all **NDL 485** units. It is independent of the IP address set at **Local Network Settings**.

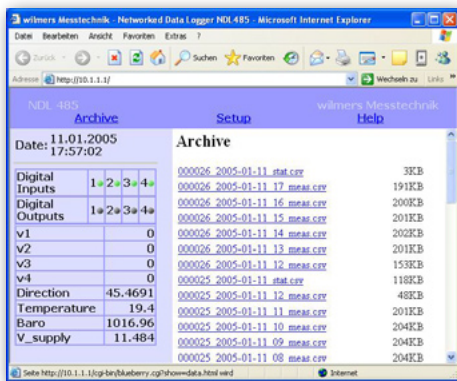

Web Interface in GSM Mode

- Enter the user name and password for the **NDL 485** and click **OK**.
- In GSM mode, the web interface provides all func-

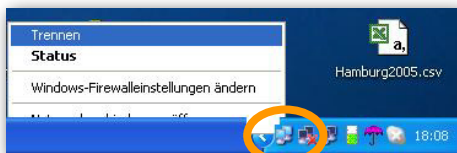

Windows Task Bar: Disconnect GSM Connection

tions that are available at local or at GPRS connection.

- To disconnect the GSM connection click on the connection icon with the right mouse button and select **Disconnect** from the popup menu.

Password Protection

Two password levels protect the **NDL 485** against unauthorized access:

The user **guest** is allowed to view actual measured data and configuration settings and to download measured data. He is allowed to set date and time. The user **guest** is not allowed to delete measured data or to change any configuration settings.

The user **admin** has all rights. He is allowed to delete measured data and to change configuration settings.



Login Dialogue

Setting the User Password

Login as user **admin** and select **Setup > Password**. Enter the new password for user **guest** and click **OK**.

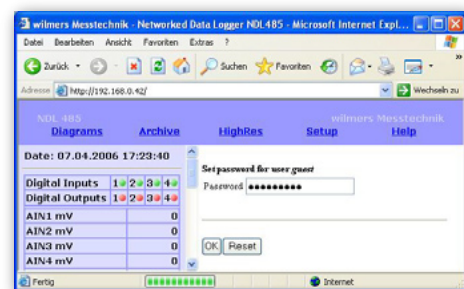

Setup > Password: User password

The password for the user **admin** cannot be changed.

Help Function

The help function the **NDL 485** provides system information about the data logger as well as an online manual.

Select **Setup > Help > About**. The dialog indicates information about type and firmware version of the data logger.

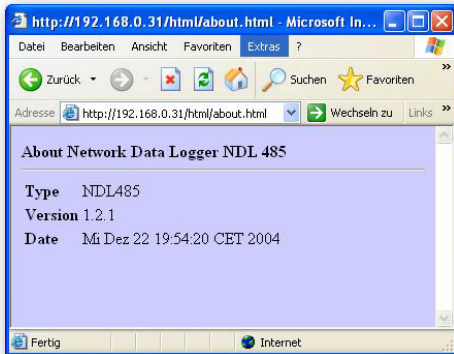

Help > About: Data Logger System Information

Select **Help > Manual** to view a short manual of the **NDL 485**.

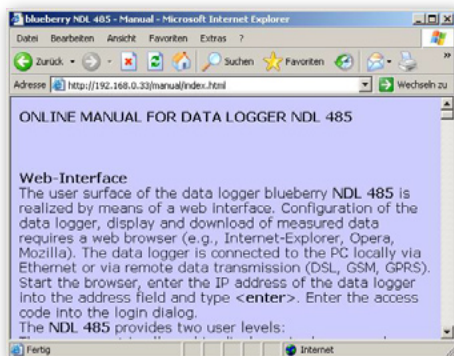

Help > Manual: Online Manual

Rebooting the NDL 485

The **NDL 485** can be rebooted in two ways: by interruption of the power supply and via the web interface. In order to reboot the **NDL 485** via the web interface please proceed as follows:

1. Start the web browser and login to the **NDL 485** as user **admin**.
2. Select **Help > About > Maintenance**.
3. Click on **Reboot** in order to start the update process.

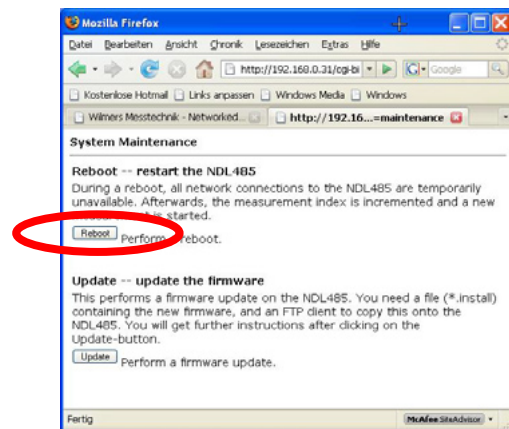

4. Wait 2 minutes until the data logger is up again.

FTP Access

Some operations, like deleting measured data and applying a firmware update require an FTP access to the **NDL 485**. The following describes the establishment of an FTP access by means of the free FTP client **FileZilla**.

Installing FileZilla

The FTP client **FileZilla** can be downloaded free of charge from the Internet at the following site:

<http://sourceforge.net/projects/filezilla>

In order to install **FileZilla** and to configure it for the **NDL 485** please proceed as follows:

1. Download the software from the above stated web-site and install it according to the instructions of the supplier.
2. Start **FileZilla**.

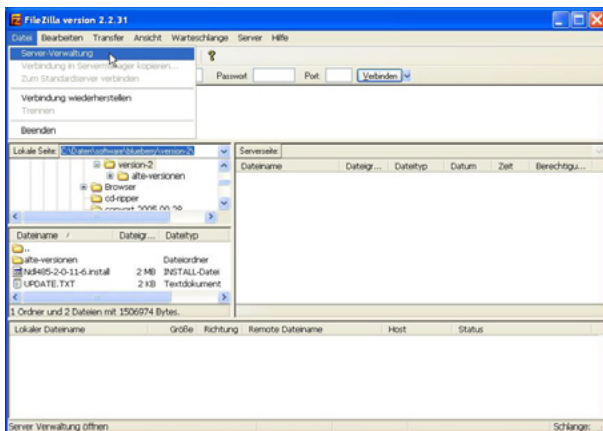

3. Select **File > Server Mangement**.

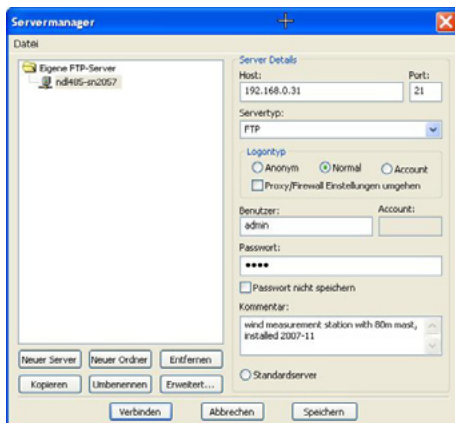

4. Select **New Server** and enter a name for the data logger.
5. Enter the IP address of the **NDL 485** into the **Host** field.
6. Select the logon type **normal**.
7. Enter the user name **admin** and the admin password of your **NDL 485**.
8. Click on **Save** to save the settings.
9. Click on **Connect** to built up the connection to the **NDL 485**. The right part of the screen displays the file system of the **NDL 485**. You can use the FTP client like a file explorer to delete measured data files from the **NDL 485** and to move files from the **NDL 485** to your local computer or from your computer to the **NDL 485**.

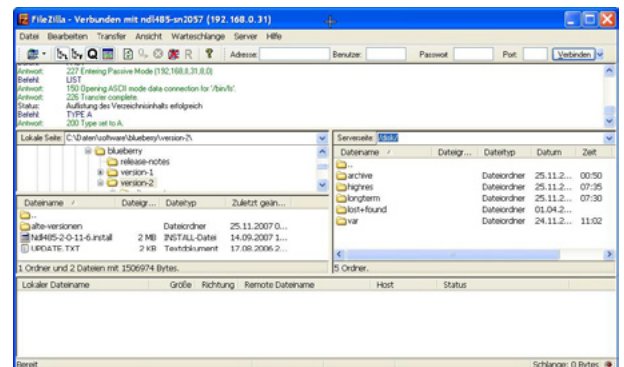

Deleting Measured Data

The **NDL 485** saves measured data in a ring buffer. The oldest data lines are automatically overwritten when the data memory is full. Usually, deleting of measured data is only necessary at the beginning of a new measurement, e.g., if the data logger is moved to another site. In order to delete measured data please proceed as follows:

1. Establish an FTP connection to the **NDL 485**.

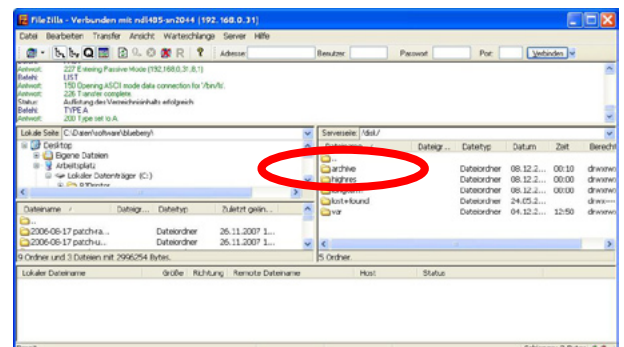

- Double click on **archive** to change to the archive directory.

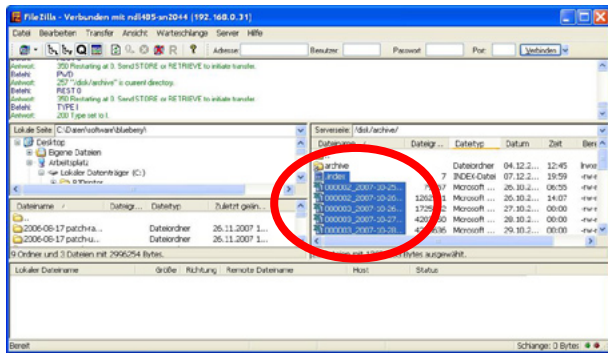

- Mark all files to be deleted and press ****.

If only data files (*.csv) are deleted the measurement index continues with the actual value. In order to reset the index please delete the file **index**.

- Click with the right mouse button on the firmware update file (e.g., Ndl485-2-0-11.install) and select **Upload**. Now, FTP transfers this file to your **NDL 485**.

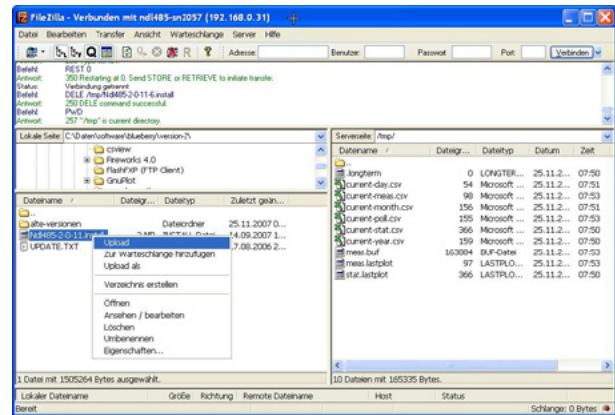

- Please wait until the transfer is successfully completed. The uploaded file is now visible in the **/tmp** folder of the **NDL 485**.

Updating the Firmware

The firmware of the **NDL 485** can be updated via local Ethernet connection or remotely via GSM, GPRS or DSL. In order to update the firmware of the **NDL 485** please proceed as follows:

- Establish an FTP connection to the **NDL 485**.
- Double click on **..** to change to the root directory.
- Open the folder **/tmp**.
- Change on the local computer to the folder that contains the firmware update file.

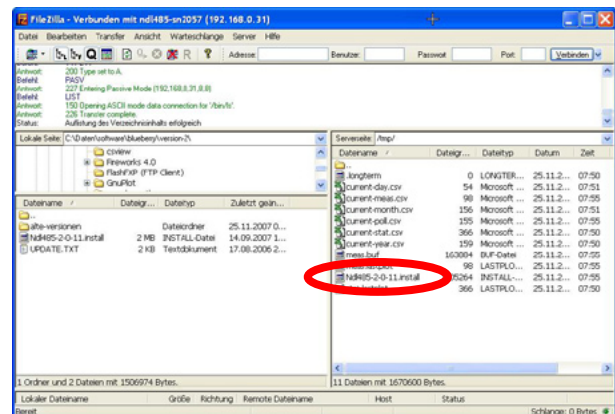

- Start the web browser and login to the **NDL 485** as user **admin**.
- Select **Help > About > Maintenance**.
- Click on **Update** in order to start the update process.

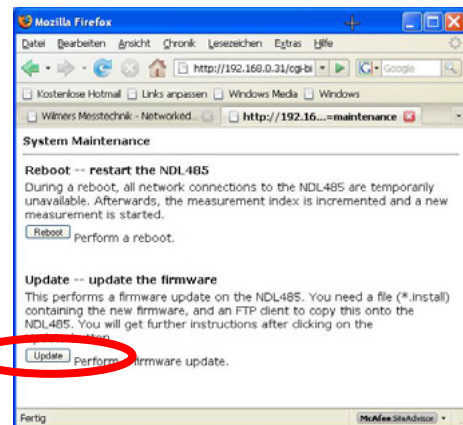
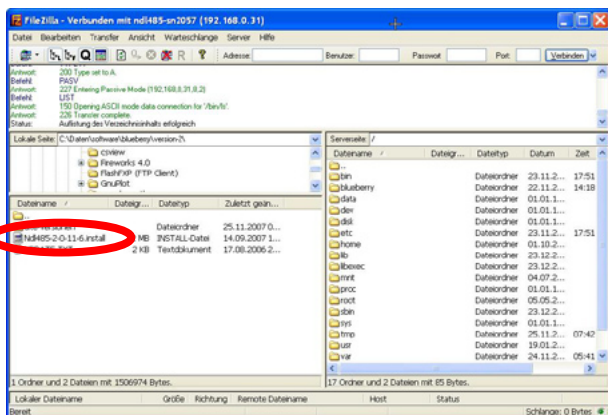

10. Please follow the instructions displayed on the screen. The update process will take approx. 5 minutes. The **NDL 485** will restart automatically after the update is completed. Regular flashing of the **BUSY** LED at the data logger indicates that the **NDL 485** is up again.

IMPORTANT NOTE:

The **NDL 485** must never be disconnected from the power supply during update process! Interruption of the update process can block the operation of the **NDL 485**.

Please restart the web browser and login to the **NDL 485**.

In order to check whether the update was successful please select **Help > About**. Check whether the indicated firmware version corresponds to the update you went to apply.

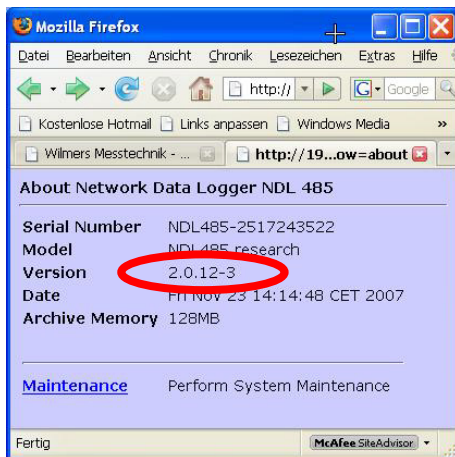

Adapting the PC Network Settings

When the **NDL 485** is connected to a PC or a LAN the network settings of the PC must comply to those of the data logger.

In order to change the network settings of the PC please proceed as follows:



1. Right click on the network icon in the task bar and select **Open Network Settings**.

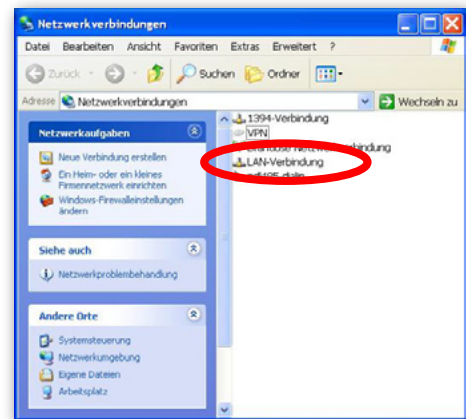

2. Double click on **LAN Connection**.

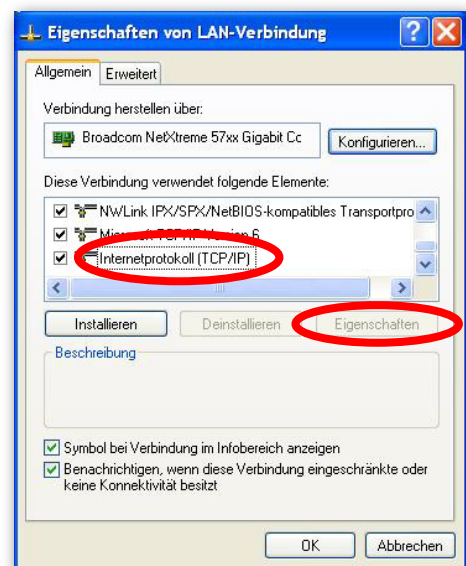

3. Select **Internet Protocol (TCP/IP)** from the list and click on **Properties**.

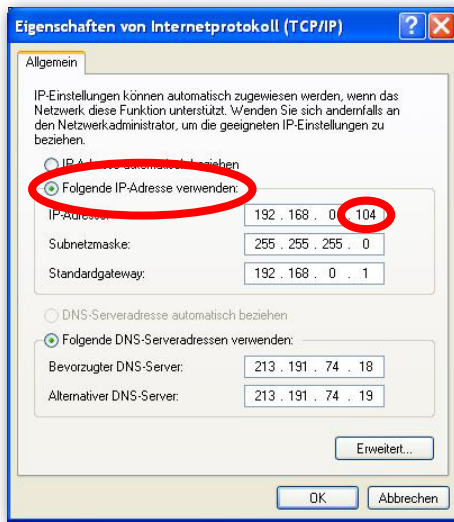

4. Activate **Use the following IP Address**. Enter the IP address, subnet mask and gateway according to the settings in the **NDL 485**. The **NDL 485** has two IP addresses: one is the fixed IP address **192.168.111.1**. This IP address cannot be changed. The second IP address can be changed by the user. Please refer to the label on the data logger for its default settings. The last entry of the IP address must be different from the setting of the data logger. All other settings must be set identical to the data logger.

Example:

Data logger: 192.168.0.31
 PC: 192.168.0.104

5. Click **Ok** to accept the settings.

EXTENDED FUNCTIONALITY (RESEARCH MODEL)

The following chapters describe the extended functionality provided by the data logger **blueberry NDL 485 research**. Please refer also to the part **Technical Data** for differences between the models **basic** (partNo. 0102) and **research** (partNo. 0103).

The main features of the **blueberry NDL 485 research** are:

- Higher sampling rate (10 Hz)
- Median function for statistics
- Larger data memory (128 MB standard, expandable to up to 1 GB)
- Generation of realtime diagrams
- Automatical data transfer via FTP

Displaying Diagrams

The **NDL 485 research** generates time series plots of actual measured values and displays them as diagrams. The user defines which measurement channels are plotted and in which order the diagrams are displayed. The texts for title and y label of the diagram axes are taken from the name of the measurement function: the first part of the function name is used as diagram title, the second part is used as y axis label. First and second part must be separated by a space character. We recommend to write function names as **Value (unit)**.

Example:

$$\mathit{relFeuchte} (\%rF) = 100 * a4$$

The diagram title for this function is **relFeuchte**, the y axis label is **(%rF)**.

Select **Diagrams** to display the diagrams.

To define the diagram options select **Setup > Diagrams**.

Enter the index of the channels to be plotted. The index corresponds to the line number in the table of measured values. Separate more than one entry by space characters. Click **OK** to save the settings.

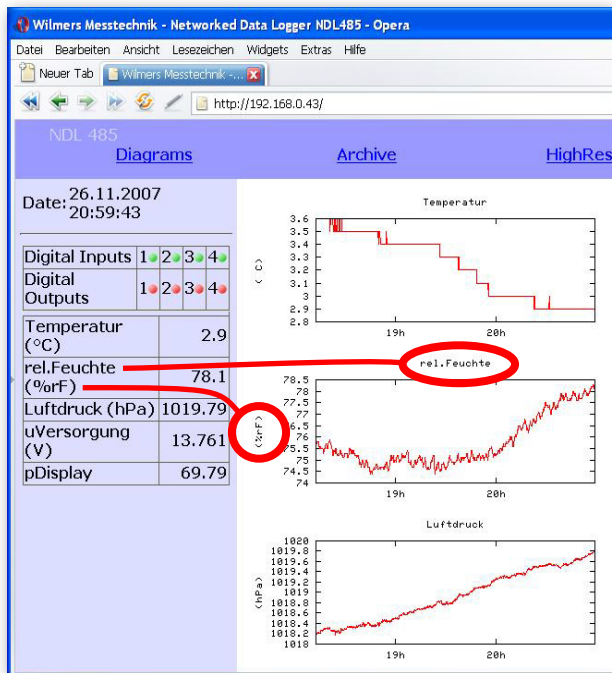

Realtime Data Diagrams

Diagrams are displayed in alphabetical order. Please add the appropriate number of 0 characters in order to determine the display order.

Example:
 entered items: 1 5 20 12
 => display order: 1 12 20 5

Example:
 entered items: 001 005 020 12
 => display order: 1 5 20 12

Shorttime Diagrams

Shorttime diagrams display a time series of the samples. Please enter the width of the diagrams in pixels or enter **disabled** if you do not want to display shorttime diagrams.

Statistics Diagrams

Statistics diagrams display a time series of the statistics. Please enter the width of the diagrams in pixels or enter **disabled** if you do not want to display statistics diagrams.

Please enter the length of the time axis of the statistics diagrams in the field **Time Range**.



Shorttime and Statistics Diagrams

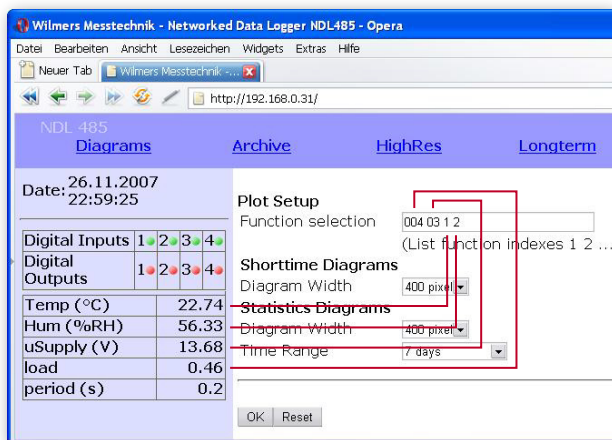

Setup for Realtime Data Diagrams

Transmitting Measured Data via FTP

The **NDL 485** (only partNo. 0103) sends measured data automatically via FTP to a website or to a data file server. Please first setup the Internet integration via DSL or GPRS.

Select **Setup > FTP/Mail**.

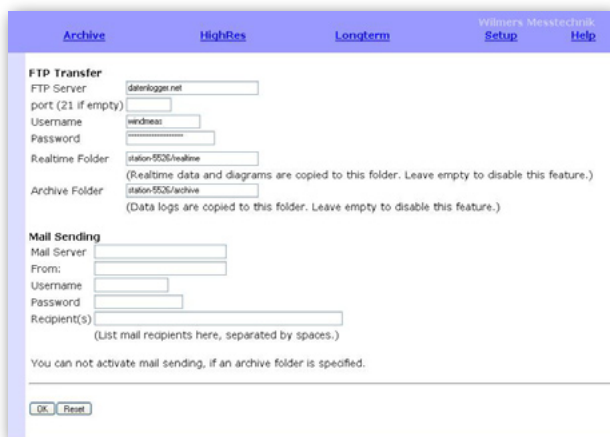

The screenshot shows a menu with options: Archive, HighRes, Longterm, Setup, and Help. The 'Setup' option is selected. Below the menu, there are two sections: 'FTP Transfer' and 'Mail Sending'. The 'FTP Transfer' section includes fields for FTP Server (datalogger.net), port (21 if empty), Username (wmdnear), Password, Realtime Folder (station-5526/realtime), and Archive Folder (station-5526/archive). The 'Mail Sending' section includes fields for Mail Server, From, Username, Password, and Recipient(s). A note at the bottom states: 'You can not activate mail sending, if an archive folder is specified.' There are 'OK' and 'Reset' buttons at the bottom left.

Setup: FTP Data Transmission (only partNo. 0103)

Enter the URL of your FTP server in the field **FTP Server**. Enter the destination folder and access code and click **OK** to save the settings.

ANNEX**Technical Specifications**

Model	NDL 485 basic	NDL 485 research
PartNo.	0102	0103
Measuring Inputs		
Digital inputs	6	6
Analogue inputs	6	6
Additional inputs	via INPUT modules (8 x AIN/DIN per module)	
Serial inputs	RS485, half-duplex, optional RS232	
Digital Measuring Inputs (DIN1 .. DIN6)		
Measuring range	frequency 0 .. 2,000 Hz counter 0 .. 2,000 Hz status HI / LO	
Resolution	0.01 Hz	
Accuracy	frequency $\pm 0.1\%$ counter ± 1 pulse	
Signal level	HI = >2.5 V LO = <0.7 V or potential free switch closure	
Input impedance	>20 k Ω	
Analogue Measuring Inputs (AIN1 .. AIN6)		
Measuring range	0 .. 10 V	
Resolution	16 Bit (0.2 mV)	
Accuracy	$\pm 0.1\%$ of reading ± 1 mV	
Input impedance	>1 M Ω	
Measuring Functions		
	NDL 485 basic	NDL 485 research
Measuring interval	1 s .. 24 h	0.1 s .. 24 h
Statistic interval	1 s .. 24 h	0.1 s .. 24 h
Statistic functions	mean value (arithmetic + vector), standard deviation (arithmetic + vector), minimum, maximum, sum	mean value (arithmetic + vector), standard deviation (arithmetic + vector), minimum, maximum, sum, median
Data memory for statistic time series	32 MB non-volatile ring buffer	128 MB, expandable to up to 1 GB, non-volatile ring buffer
Data memory for samples	32 MB non-volatile ring buffer	

Communication	NDL485 basic	NDL485 research
Data interface	RS232 interface, 1,200 .. 115,200 baud, RS485 interface, half-duplex, 1,200 .. 115,200 baud, Ethernet interface (LAN), 10 MBit/s, optional MODBUS-TCP protocol	
Remote data transfer	GSM, GPRS, DSL, ISDN router	
Automatical data transmission	via eMail	via eMail and FTP
Internet integration	via GPRS or DSL	
User interface	web interface, Internet browser	
Graphical data display	-	realtime diagrams of measured values, optional custom specific graphical display
Display	-	
Power Supply		
External power supply	5 .. 24 VDC	
Internal power supply	-	
Power consumption	typ. 600 mW (50 mA @ 12 V)	
Sensor excitation EXC	5..24 VDC switched, max. 500 mA	
Switching outputs DOUT1 .. DOUT4	4 switching outputs, max. 300 mA, HI = supply voltage, LO = 0 V, time or event triggered	
Mechanic and Operation Conditions		
Casing	65 x 105 x 127 mm, IP20 top-hat rail housing, anodized aluminium	
Connections	screw terminals, connectors	
Temperature range	-40..+70 °C	

CE Compliancy Declaration

Based on test report no. EMV-08/8117-1 of 22.07.2008

Manufacturer: Wilmers Messtechnik GmbH
Hammer Steindamm 35
D-22089 Hamburg / Germany

Product: Data logger **blueberry NDL 485**

Part numbers: 0102 (basic)
0103 (research)

Applied standards:

Index

Symbols

!= 16
 ! (NOT operator) 16
 #AA\r (poll command) 20
 # (last value operator) 17
 % (modulo operator) 15
 () 17
 < 15
 <= 16
 == 16
 > 15
 >= 16
 ^ 15
 0102 (NDL485 version) 37
 0103 (NDL485 version) 37
 10.1.1.1 (IP address) 29
 192.168.111.1 (fixed IP address) 34

A

abs 17
 Accuracy 37
 actual measured values 8
 addition 15
 address 20
 admin 29
 AIN1 20
 alignment 13
 analogue measurement inputs 20
 analog (poll command) 20
 AND (operator) 16, 21
 APN (GPRS Access Point Name) 23

B

Barometric pressure 21
 basic (NDL485 version) 37
 Baudrate 19
 baud rate 19
 blueberry GSM Module 27
 blueberry INPUT Module 5, 20
 Boolean Operators 15
 boolean operators 15, 21
 browse 27
 browser 29
 BUSY indicator 5
 BUSY LED 6, 33

C

calibration 13
 Casing 38
 CC1 21
 CC2 21
 Character Delay 19
 column headers 10
 comma separated ASCII files 10
 compact 26
 Comparison 15, 16
 comparison 15, 16
 Connections 38
 constant current supply 21
 coordinate system 13
 cos 15
 Cosine function 15
 counted pulses 18
 counter 20
 crosspatch cable 6, 22
 crosspatch Ethernet cable 5
 CSV data file 12
 CSV file 10

D

damped value 17
 data format 10, 21
 data memories 10
 Data memory 37
 Date 22
 DAY 19
 DAYTIME 18
 decimal 21
 Decimal delimiter 10
 delete measured data 29
 Deleting Measured Data 31
 diagrams 34
 diagram titel 15
 dial-in 27
 dial-in connection 23
 digital (poll command) 20
 digital measurement inputs 20
 digital outputs 21
 DIN1 20
 disconnect 29
 division 15
 Documentation 12
 documentation 12
 DOUT1 .. DOUT4 21
 download of measured data 10, 35
 DSL 12
 Dynamic DNS 23
 Dynamic DNS Service 24
 dynamic IP address 23, 24

dyndns.org 23, 24
DynDNS Account 24
DynDNS host 25

E

e-mail 12
e-mail address 12
elevation 12
else 16
Ethernet 22
EXC 5, 14, 20
Excitation 14
excitation voltage 14
EXC indicator 5
Exponent 15
exponent 15

F

FileZilla 31
Filtering of Invalid Samples 16
firmware update 32
firmware version 30, 33
fixed IP address 34
flashing light 18, 21
floating point numbers 8
frequency 18, 20
FTP/Mail 12
FTP client 31
FTP data transfer 36
FTP Server 36
function name 14

G

gateway 34
geographical coordinate system 13
Geographical Position 12
GPRS 23
GPRS connection 29
GPRS Internet Connection 23
GPRS mode 23
gradient 18
GSM mode 23, 29
GSM Module 23, 27
GSM provider 23
guest 29

H

half-duplex 37
Help 30
Help > About 33

Help > About > Maintenance 32
Help > Manual 30
help function 30
hex 21
hexadecimal values 21
HOUR 19
hysteresis 21

I

if 16
IN1 20
index 32
Input impedance 37
input impedance 37
INPUT Module 5, 18, 19, 20
int 17
integration 18
Internet 22, 23, 26
Internet access 26
Internet integration 12, 36
Internet server 27
IP address 22, 23, 29, 34

L

LAN 22
latitude 12
ln 15
logarithm 15
login 6, 8
login dialog 26
longitude 12

M

M12x1 connector 5
mail addresses 12
Mail Server 12
Maintenance 32
Manual 30
manual 30
Marking of Invalid Samples 16
mast type 13
MDA 26
measurement function 14
measurement functions 19
measurement inputs 20
measurement process 12
measurement site 12
measure period 14

MINUTE 19
mobile access 26
mobile browser 26
mobile device 26
Mobile Phone 26
mobile phone 26, 27
MODBUS 38
modem 27
modulo division 15
MONTH 19
mounting booms 13
multiplication 15

N

Name of the measurement site 12
nan (not a number) 16, 19
Natural logarithm 15
NDL 485 basic 37
NDL 485 research 37
Network 22
network 22
network settings 33
NOT operator 16

O

obstacles 12
Onboard temperature 21
online manual 30
Opera 27
operamini 27
orography 12
OR (operator) 16

P

Password 24
password 23, 29
PC network (LAN) 22
PC Network Settings 33
PERIOD 18
period 10
pocket PC 26
poll address 20
Poll Command 19
poll command 19
poll pause 19
Power consumption 38
Power Supply 38
power supply 20, 21
PPP 27
pressure sensor 21
previous measurement 18

previous value 17
public APN 23
pulses 18

R

realtime access 23
realtime clock 22
realtime diagrams 14
Rebooting 30
Remote Access 24
Remote Access via Internet 24
remote connection 27, 28
remote data transmission 23
research (NDL485 version) 37
Resolution 37
Retry 19
ring buffer 37
roughness 12
round 17
Rounding Operators 17
RS232 5
RS485 37
RS485, half-duplex 37
RS485 bus 19
RS485 bus wiring 6

S

SECOND 19
sensors 13
sensor characteristics 14
sensor mounting booms 13
Serial inputs 37
serial number 10
serial numbers 13
Shorttime Diagrams 35
Signal level 37
sin 15
Sine function 15
Site Description 12
sonic anemometers 5, 19
statistical evaluations 14
Statistics Diagrams 35
statistics files 10
statistic interval 14
status HI / LO 37
subnet mask 34
subtraction 15
switching output 16
Switching outputs 38
synchronization 22

T

TCP/IP 34
Technical Data 32
Temperature range 38
TIME 18
Time 22
timer 21
Time Info 18
time series plots 34
time server 22
time zone 22

U

Update 32
Updating the Firmware 32
Username 24
user admin 29
user guest 29
User Password 29
UTC 22

V

valid 16
Validity Check 16
validity check 16
variables 14, 18
vector 15
virtual channels 19
Voltage 20

W

web interface 8, 26, 29
web server 23
WEEKDAY 19
wind speed vector 15
wiring of RS485 bus 6

Y

YEAR 19
YEARDAY 19



Capturing the Future

Wilmers Messtechnik GmbH • Hammer Steindamm 35 • D-22089 Hamburg • Germany

phone: +49(0)40-75 66 08 98 • fax: +49(0)40-75 66 08 99 • mail: info@wilmers.com

www.wilmers.com